

THE 1, 2, 3-CONJECTURE AND 1, 2-CONJECTURE FOR SPARSE GRAPHS

DANIEL W. CRANSTON

Virginia Commonwealth University
Richmond, VA, USA

e-mail: dcranston@vcu.edu

SOGOL JAHANBEKAM¹

University of Colorado Denver
Denver, CO, USA

e-mail: sogol.jahanbekam@ucdenver.edu

AND

DOUGLAS B. WEST²

Zhejiang Normal University, Jinhua, China
and University of Illinois, Urbana, IL, USA

e-mail: west@math.uiuc.edu

Abstract

The 1, 2, 3-Conjecture states that the edges of a graph without isolated edges can be labeled from $\{1, 2, 3\}$ so that the sums of labels at adjacent vertices are distinct. The 1, 2-Conjecture states that if vertices also receive labels and the vertex label is added to the sum of its incident edge labels, then adjacent vertices can be distinguished using only $\{1, 2\}$. We show that various configurations cannot occur in minimal counterexamples to these conjectures. Discharging then confirms the conjectures for graphs with maximum average degree less than $8/3$. The conjectures are already confirmed for larger families, but the structure theorems and reducibility results are of independent interest.

Keywords: 1, 2, 3-Conjecture, 1, 2-Conjecture, reducible configuration, discharging method.

2010 Mathematics Subject Classification: 05C15, 05C22, 05C78.

¹Research supported in part by National Science Foundation grant DMS 09-01276.

²Research supported in part by National Security Agency grant H98230-10-1-0363.

1. INTRODUCTION

Coloring problems in graph theory may generate vertex colorings in various ways. We consider colorings produced from weights on the edges and vertices.

Let $V(G)$ and $E(G)$ denote the vertex set and edge set of a graph G , and let $\Gamma_G(v)$ denote the set of edges incident to a vertex v . An S -weighting of a graph G is a map $w: E(G) \rightarrow S$. A total S -weighting is a map $w: E(G) \cup V(G) \rightarrow S$. More specifically, a k -weighting is an S -weighting with $S = \{1, \dots, k\}$. For a weighting w , let $\phi_w(v) = \sum_{e \in \Gamma_G(v)} w(e)$. For a total weighting w , let $\phi_w(v) = w(v) + \sum_{e \in \Gamma_G(v)} w(e)$; that is, each vertex is assigned the total of the weights it “sees”. A weighting or total weighting w is *proper* if ϕ_w is a proper coloring of G . We seek proper k -weightings or proper total k -weightings for small k .

Conjecture 1.1 (1, 2, 3-Conjecture; Karoński-Luczak-Thomason [7]). *Every graph without isolated edges has a proper 3-weighting.*

Conjecture 1.2 (1, 2-Conjecture; Przybyło-Woźniak [8]). *Every graph has a proper total 2-weighting.*

The original paper proved the 1, 2, 3-Conjecture for graphs with chromatic number at most 3. Addario-Berry *et al.* [1] showed that every graph without isolated edges has a proper k -weighting when $k = 30$. After reductions to $k = 15$ in [2] and $k = 13$ in [10], Kalkowski, Karoński, and Pfender [6] showed that every graph without isolated edges has a proper 5-weighting.

Przybyło and Woźniak [8] proved the 1, 2-Conjecture for complete graphs and for graphs with chromatic number at most 3. Kalkowski [5] showed that every graph has a proper total 3-weighting; furthermore, there is such a weighting with the edge weights in one spanning tree fixed arbitrarily and the vertex weights chosen from $\{1, 2\}$. Seamone [9] surveyed progress on these and related problems.

List extensions of the two conjectures have been proposed. A graph is *k -weight-choosable* if whenever each edge is given a list of k available integers, a proper weighting can be chosen from the lists. A graph is *(k, k') -weight-choosable* if whenever each vertex has a list of size k and each edge has a list of size k' , a proper total weighting can be chosen from the lists.

Conjecture 1.3 (Bartnicki-Grytczuk-Niwczyk [4]). *Every graph without isolated edges is 3-weight-choosable.*

Conjecture 1.4 (Wong-Zhu [12]). *Every graph is $(2, 2)$ -weight-choosable. Every graph without isolated edges is $(1, 3)$ -weight-choosable.*

These conjectures are stronger than the original conjectures, which consider only the special case of lists consisting of the smallest positive integers. Wong, Yang, and Zhu [11] proved that the complete multipartite graph $K_{n,m,1,1,\dots,1}$ is

(2, 2)-weight-choosable and that complete bipartite graphs other than K_2 are (1, 2)-weight-choosable. Bartnicki, Grytczuk, and Niwczyk [4] applied the Combinatorial Nullstellensatz [3] to prove Conjecture 1.3 for complete graphs, complete bipartite graphs, and trees. Wong and Zhu [12] applied the Combinatorial Nullstellensatz to prove Conjecture 1.4 for complements of linear forests; this includes complete graphs. They also proved that every tree with an even number of edges is (1, 2)-weight-choosable. Wong, Yang, and Zhu [11] continued this approach, proving Conjecture 1.4 for graphs with maximum degree 3. Finally, Wong and Zhu [13] proved that every graph is (2, 3)-weight-choosable.

In this paper, we show that various configurations cannot occur in minimal counterexamples to Conjectures 1.1 and 1.2. To discuss them together, let j -weighting mean a 3-weighting when $j = 3$ and a total 2-weighting when $j = 2$. A graph is j -bad if it has no proper j -weighting (and no isolated edge if $j = 3$). A configuration that cannot occur in a minimal j -bad graph is j -reducible.

In this context, a *configuration* consists of a graph C plus labels $f: V(C) \rightarrow \mathbb{N}$. The configuration *occurs* in G if C appears as a subgraph H of G such that $d_G(v) = f(v)$ for $v \in V(H)$. A configuration is proved j -reducible by showing that if it occurs in G , then G has an induced subgraph G' such that every proper j -weighting of G' yields a proper j -weighting of G (possibly by changing some weights before extending to G).

Our reducibility results imply Conjectures 1.1 and 1.2 for sparse graphs via the discharging method. By “sparse”, we mean $\text{Mad}(G) < c$ for some c , where the *maximum average degree* $\text{Mad}(G)$ of a graph G is $\max_{H \subseteq G} \bar{d}(H)$, and $\bar{d}(H) = \frac{\sum_{v \in V(H)} d_H(v)}{|V(H)|}$. To show that $\bar{d}(G) < c$ forces some desired configuration, we give each vertex initial charge equal to its degree and specify “discharging rules” to move charge so that when no specified configuration occurs, every vertex has final charge at least c . Proving that $\bar{d}(G) < 8/3$ forces a j -reducible configuration confirms the conjectures when $\text{Mad}(G) < 8/3$. However, that is already known, since all subgraphs of such graphs have minimum degree at most 2 and hence are 3-colorable. The original papers proved the conjectures for 3-colorable graphs.

The value of our results is thus in the structure theorems proved by discharging (which may be useful for other problems) and in the reducibility theorems prohibiting various configurations from minimal counterexamples. Like the original proofs for 3-colorable graphs, our proofs are constructive and hence yield polynomial-time algorithms to find proper j -weightings.

Our proofs of j -reducibility use the restriction of weights to values at most j , so they do not extend to the list versions. Also, unlike in most coloring problems, vertices of degree 1 do not immediately yield reducible configurations, since the weight on a pendant edge affects whether its incident edges are properly colored.

For clarity, we first present in Section 2 short proofs that suffice for the case $\text{Mad}(G) < 5/2$. These arguments are used in and motivate the stronger results

in later sections. We begin with some 3-reducible configurations. We next show by discharging that $\bar{d}(G) < 5/2$ forces some configuration in this set. We then prove 2-reducibility for similar configurations. Both results for $\text{Mad}(G) < 5/2$ use the same discharging argument, although the sets of reducible configurations are different.

When $\text{Mad}(G) \geq 5/2$, no longer must G have a configuration among those in Section 2. In Section 3 and Section 4, respectively, we obtain sets of 2-reducible and 3-reducible configurations that are unavoidable when $\text{Mad}(G) < 8/3$.

2. REDUCIBLE CONFIGURATIONS AND $\text{Mad}(G) < 5/2$

In discharging arguments for sparse graphs, it is convenient to have concise terminology for vertices satisfying degree constraints.

Definition 2.1. A vertex with degree k , at least k , or at most k is a k -vertex, a k^+ -vertex, or a k^- -vertex, respectively. A j -neighbor of v is a j -vertex adjacent to v . Write $N_G(v)$ for the neighborhood of v in G and $d_G(v)$ for its degree. For $v \in V(G)$ and $U \subseteq N_G(v)$, let $[v, U]$ denote the set of edges joining v to U .

A weighting or total weighting w satisfies an edge uv if $\phi_w(u) \neq \phi_w(v)$, or equivalently if $\rho_w(u, v) \neq \rho_w(v, u)$, where we define $\rho_w(x, y) = \phi_w(x) - w(xy)$ when x and y are adjacent.

A configuration in a graph G is a subgraph C together with specified degrees in G for $V(C)$. The core of the configuration is $E(C)$, and the resulting derived graph is $G - E(C)$.

We begin with a lemma that shortens reducibility proofs: 1-neighbors are “easier” to handle than 2-neighbors, so when we claim that a configuration is reducible when a particular vertex has degree 1 or 2, in the proof we may assume that it has degree 2.

Lemma 2.2. *If a vertex z in a j -reducible configuration C has degree 1 in C and is specified to have degree 2 in the full graph, then the configuration C' obtained from C by instead specifying degree 1 for z is also j -reducible.*

Proof. Let H be a graph containing C' , and let H' be the derived graph; z is isolated in H' . Form G from H by adding vertices a and b and edges ab and bz . Now C arises in G , and the derived graph G' arises from H' in the same way that G arises from H .

If H is a minimal j -bad graph, then H' has a proper j -weighting. Since the path P_3 has such a weighting, also G' has such a weighting. Since C is j -reducible, G has a proper j -weighting. To obtain the desired weighting of H , note that all edges remain satisfied when a and b are deleted from the weighting of G except

possibly zv . For $j = 2$, the weight on z is needed only to satisfy zv in H and can be respecified so that zv is satisfied. For $j = 3$, the edge zv is satisfied automatically since $d_H(v) > 1$. ■

Reducibility proofs may use some types of inferences many times. The next lemma enables us to express statements concisely. It can be phrased more generally, but for clarity we list just typical situations where we will use it.

Lemma 2.3. *Let w be a partial j -weighting of a graph G (w is not specified everywhere). In the situations below, the weights on a set S can be chosen to satisfy the edges in a set F if the weights on all the edges (or vertices) incident to F and not in S are already known.*

- (1) *The edges of F have a common endpoint v , incident to all edges of S (possibly also $v \in S$ when $j = 2$), and $|F| \leq (j - 1)|S|$.*
- (2) *F consists of two edges, S is a single edge incident to both, and $j = 3$.*

Proof. Let $k = |S|$. Since weights are chosen from $\{1, \dots, j\}$, the sum of k weights has $1 + (j - 1)k$ possible values. Each edge in F uses that sum in determining whether the values of ϕ differ at its endpoints. Each edge in F thus forbids at most one value of the sum in a proper j -weighting. There are at least $k(j - 1)$ possible augmentations above the least value of the sum, so when $k(j - 1) \geq |F|$ the labels can be chosen to satisfy all of F .

Note that in (2) the weights on F may be unspecified; the weight on an edge does not affect whether it is satisfied. Similarly, if $F = \{uv\}$, and S is a single edge incident to v or is v itself, and the weights of all other items incident to uv are known, then the weight on S can be chosen in $j - 1$ ways to satisfy F . ■

Remark 2.4. We use Lemma 2.3 frequently in reducibility arguments, invoked without mention in 2-reducibility when we write “choose $w(vz)$ to satisfy vx ” or “choose $w(v)$ and $w(vz)$ to satisfy vx and vv ”. In 2-weightings we can choose one weight to avoid one value, but in 3-weightings it can avoid two values.

Another way to satisfy an edge uv is to create enough imbalance between the contributions at u and v to guarantee that $\phi(u) \neq \phi(v)$ when the weighting is completed. When we write “Set $w(uv) = 3$ to ensure satisfying vz ”, we mean that no way of choosing weights on the remaining edges can produce $\phi(u) = \phi(v)$. Saying that an edge is “automatically satisfied” has a similar meaning. For example, any edge joining a 1-vertex to a 3-vertex is automatically satisfied for (total) 2-weightings, while putting weight 1 at the 1-vertex ensures satisfying the edge even when the neighbor has degree 2.

The figures for configurations show the core in bold, the derived graph G' is obtained by deleting the core. Also, with w' assumed to be a proper j -weighting of G' , the label on an edge e is $w'(e)$, and the label in a circle at a vertex x with

one neighbor u is $\rho_{w'}(x, u)$. To satisfy xu , the sum of the contributions at u other than $w'(xu)$ must differ from $\rho_{w'}(x, u)$.

The figures do not show cases where some of the specified vertices may be equal. For instances where such equalities do not affect the validity of the written argument, we make no comment about possible changes in the illustration.

Proving reducibility for a configuration means modifying or extending a proper j -weighting w' of the derived graph G' to obtain a j -weighting w of G such that the edges in or incident to the core become satisfied, while the other edges of G' remain satisfied. If we do not change the weights on edges of G' incident to the core, then all edges of G' not incident to the core remain satisfied.

With these preparations, we begin the reducibility arguments. The first lemma takes care of many degenerate cases of later configurations in which specified vertices may be identical.

Lemma 2.5. *The following configurations are both 2-reducible and 3-reducible.*

- (1) *A 3-cycle through two 2-vertices and one 4^- -vertex.*
- (2) *A 3-cycle through one 2-vertex z and two vertices that each may be a 3-vertex, a 4-vertex with a 1-neighbor, or a 5-vertex with a 1-neighbor. Also, one neighbor of z may be a 4-vertex with a 2-neighbor other than z .*

Proof. When G is a 3-cycle, the weights can be chosen to produce colors $\{3, 4, 5\}$ at the vertices, for either value of j . When $G \neq C_3$, we extend a proper j -weighting w' of a subgraph G' obtained by deleting the core (see Figure 1).

For (1), let v be the 3^+ -vertex and $\{z, z'\}$ the 2-vertices on the cycle. To extend w' to w , first set $w(zz') = 1$. If $j = 2$, then set $w(v) = 2$ to ensure satisfying vz and vz' ; next fix $w(z) = 1$, choose $w(vz)$ and $w(vz')$ to satisfy $\Gamma_{G'}(v)$, and choose $w(z')$ to satisfy zz' . If $j = 3$, then require $w(vz) \neq w(vz')$ with $w(vz) \in \{1, 2\}$ and $w(vz') \in \{2, 3\}$ to satisfy zz' . There are three choices for $w(vz) + w(vz')$, so we can choose them also to satisfy $\Gamma_{G'}(v)$, since $d_{G'}(v) \leq 2$.

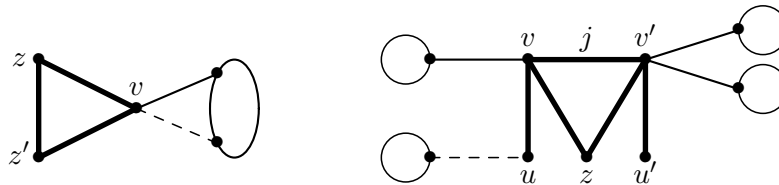

Figure 1. Cases (1) and (2) for Lemma 2.5.

For (2), let v and v' be the other vertices of the triangle. If $d_G(v) \geq 4$, then let u be a vertex of smallest degree in $N(v) - \{z\}$; similarly define $u' \in N(v')$.

Form G' from G by deleting $\{vz, v'z, vv'\}$ and the edges vu and $v'u'$ (if they exist). Figure 1 shows one of the possibilities at each of v and v' .

We first ensure that vz and $v'z$ will be satisfied by setting $w(vv') = j$ (and $w(z) = 1$ if $j = 2$). This will yield $\rho_w(z, v) \leq 3 < 4 \leq \rho_w(v, z)$, since $d_G(v) \geq 3$.

For $d_G(v) = 3$, choose $w(vz)$ (and $w(v)$ if $j = 2$) to satisfy the one edge in $\Gamma_{G'}(v)$. For $d_G(v) \in \{4, 5\}$ and $d_G(u) = 1$, choose $w(vz)$ and $w(vu)$ (and $w(v)$ if $j = 2$) to satisfy $\Gamma_{G'}(v)$. These cases have extra flexibility, so that if all contributions to $\phi_w(v')$ are already known, then vv' can also be satisfied.

For $d_G(v) = 4$ and $d_G(u) = 2$, choose $w(vu)$ (and $w(u)$ if $j = 2$) to satisfy $\Gamma_{G'}(u)$, and then choose $w(vz)$ (and $w(v)$ if $j = 2$) to satisfy vu and $\Gamma_{G'}(v)$. In this case we do not satisfy vv' using edges at v . Instead, we satisfy vv' using one of the earlier cases at v' after $\phi_w(v)$ is known; this case is only allowed to occur at one of $\{v, v'\}$. ■

Lemma 2.6. *The following configurations are 3-reducible.*

- A. A 2-vertex or 3-vertex having a 1-neighbor.
- B. A 4^- -vertex whose neighbors all have degree 2.
- C. A 3-vertex having two 2-neighbors, one of which has a 2-neighbor.
- D. A 4-vertex having a 1-neighbor and a 2^- -neighbor.
- E. A 5^+ -vertex v with $3p_1 + 2p_2 \geq d_G(v)$, where v has p_i i -neighbors.

Proof. Let v be such a vertex in a graph G . Let U_i be the set of i -neighbors of v . Form G' as in Definition 2.1 (deleting the bold core), except that also any resulting isolated edges are deleted. We obtain a proper 3-weighting w of G from a proper 3-weighting w' of G' .

Case A: $d_G(v) \leq 3$ and v has a 1-neighbor u . As in Lemma 2.3, we can choose $w(uv)$ to satisfy the other edges at v . With $d_G(v) \geq 2$, the edge uv is automatically satisfied.

By Case A, deleting the core in Cases B, C, D leaves no isolated edges.

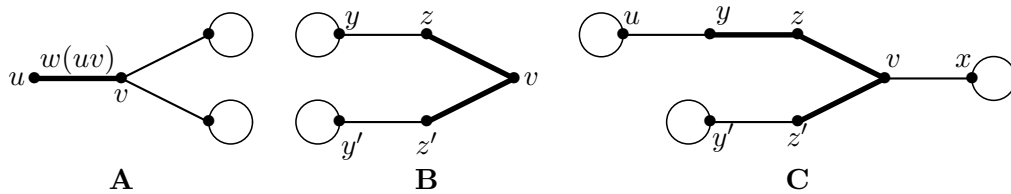

Figure 2. Cases A, B, C for Lemma 2.6.

Case B: $d_G(v) \leq 4$ and $U_2 = N_G(v)$. Let z and z' be 2-neighbors of v , with $N_G(z) = \{v, y\}$ and $N_G(z') = \{v, y'\}$. By Lemma 2.5, $\{y, y'\} \cap \{z, z'\} = \emptyset$. Let $G' = G - \{vz, vz'\}$. For $d_G(v) = 2$ (Figure 2B), choose $w(vz)$ to satisfy yz and

vz' , and $w(vz')$ to satisfy $y'z'$ and vz . If $d_G(v) \in \{3, 4\}$, then for $z \in N_G(v)$ with $zy \in E(G')$, choose $w(vz) \in \{2, 3\} - \{\rho_{w'}(y, z)\}$ to satisfy yz . Since $d(v) \geq 3 \geq w'(zy)$, such choices on $\Gamma_G(v)$ also satisfy zv .

Case C: $d_G(v) = 3$ and $U_2 = \{z, z'\}$, with y a 2-neighbor of z . By Lemma 2.5, $y \neq z'$. Let $G' = G - \{vz, vz', zy\}$, leaving $vx, z'y', yu \in E(G')$ (see Figure 2C). Choose $w(vz)$ to satisfy zy and vz' , then $w(vz')$ to satisfy $z'y'$ and vx , and finally $w(zy)$ to satisfy yu and vz .

Case D: $d_G(v) = 4$ and $N_G(v) = \{u, z, x, x'\}$ with $d_G(u) = 1$ and $d_G(z) \leq 2$. By Lemma 2.2, we may assume $d_G(z) = 2$. Let $G' = G - \{vu, vz\}$, leaving $zy \in E(G')$ (see Figure 3D, where y may be in $N_G(v)$). When choosing $w(vz)$ to satisfy zy and choosing $w(vu)$ to satisfy vz , each has at least two possible values. Hence they can be chosen with three possible values for $w(vz) + w(vu)$, yielding a choice that also satisfies vx and vx' .

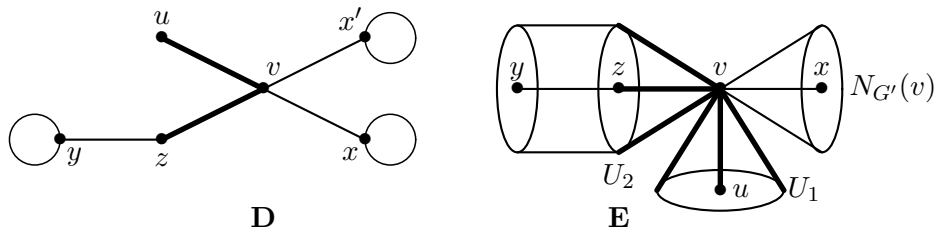

Figure 3. Cases D and E for Lemma 2.6.

Case E: $d_G(v) \geq 5$ and $3p_1 + 2p_2 \geq d_G(v)$. For $z \in U_2$, let y be the neighbor of z in G' . To satisfy yz when $y \notin U_2$ (see Figure 3E), we need $w(vz) \neq \rho_{w'}(y, z)$; there are at least two such choices for $w(vz)$. (If $y \in U_2$, then yz is deleted in G' ; let $w(yz) = 1$. Now $w(vy) \neq w(vz)$ is needed to satisfy yz , leaving three choices for $w(vy) + w(vz)$.)

Edges to U_1 are automatically satisfied, since $d_G(v) \geq 2$. For $z \in U_2$, the edge zv will be satisfied, since $d_G(v) \geq 5$ yields $\rho_w(v, z) \geq 4 > 3 \geq w(zy)$.

It remains to satisfy $\Gamma_{G'}(v)$. Let $\sigma = \sum_{e \in E(G) - E(G')} w(e)$. We need $\sigma \neq \phi_{w'}(x) - \phi_{w'}(v)$ when $x \in N_{G'}(v)$, so σ must avoid $d_G(v) - p_1 - p_2$ values. It suffices to have $1 + 2p_1 + p_2$ choices for σ , since we are given $2p_1 + p_2 \geq d_G(v) - p_1 - p_2$. Weights on $[v, U_1]$ have three choices. Weights on $[v, U_2]$ have at least two choices, except that weights on two such edges incident to neighboring 2-vertices instead have three choices for their sum. Starting with the smallest choices, we can therefore make $2p_1 + p_2$ augmentations to the sum using choices that satisfy the edges incident to U_2 . Hence there are enough choices for σ to satisfy $\Gamma_{G'}(v)$. ■

We now use discharging to obtain an unavoidable set of configurations.

Lemma 2.7. *Let G be a graph with no isolated edges. If $\bar{d}(G) < 5/2$, then G contains one of the following configurations.*

- A.** *A 2-vertex or 3-vertex having a 1-neighbor.*
- B.** *A 4^- -vertex whose neighbors all have degree 2.*
- C.** *A 3-vertex having two 2-neighbors, one of which has a 2-neighbor.*
- D.** *A 4-vertex having a 1-neighbor and a 2^- -neighbor.*
- E.** *A 5^+ -vertex v with $3p_1 + p_2 \geq 2d_G(v) - 4$, where v has p_i i -neighbors.*

Proof. We prove that avoiding **A–E** requires $\bar{d}(G) \geq 5/2$. Give each $v \in V(G)$ initial charge $d_G(v)$. Move charge by the following rules:

- (R1) Each 4^+ -vertex gives $\frac{3}{2}$ to each 1-neighbor and $\frac{1}{2}$ to each 2-neighbor.
- (R2) Each 3-vertex with a 2-neighbor gives total $\frac{1}{2}$ to its 2-neighbors, split equally if it has two 2-neighbors.

Let $\mu(v)$ denote the resulting charge at v . It suffices to show $\mu(v) \geq \frac{5}{2}$ for all v . For $\mathbf{Z} \in \{\mathbf{A}, \mathbf{B}, \mathbf{C}, \mathbf{D}, \mathbf{E}\}$, let $\bar{\mathbf{Z}}$ mean “configuration \mathbf{Z} does not occur in G ”.

Case $d_G(v) = 1$. By $\bar{\mathbf{A}}$, the neighbor of v has degree at least 4, so $\mu(v) = \frac{5}{2}$.

Case $d_G(v) = 2$. By $\bar{\mathbf{A}}$ and $\bar{\mathbf{B}}$, v has a 3^+ -neighbor that gives it $\frac{1}{4}$ or $\frac{1}{2}$. If only $\frac{1}{4}$, then by $\bar{\mathbf{C}}$ v also receives at least $\frac{1}{4}$ from its other neighbor, so $\mu(v) \geq \frac{5}{2}$.

Case $d_G(v) = 3$. By $\bar{\mathbf{A}}$ and $\bar{\mathbf{B}}$, v has no 1-neighbor and at most two 2-neighbors. Hence v gives away 0 or $\frac{1}{2}$, and $\mu(v) \geq \frac{5}{2}$.

Case $d_G(v) = 4$. By $\bar{\mathbf{D}}$ and $\bar{\mathbf{B}}$, v loses charge only to one 1-neighbor or to at most three 2-neighbors. It loses at most $\frac{3}{2}$, and $\mu(v) \geq \frac{5}{2}$.

Case $d_G(v) \geq 5$. v gives $\frac{3}{2}$ to each 1-neighbor and $\frac{1}{2}$ to each 2-neighbor. By $\bar{\mathbf{E}}$, $\mu(v) = d_G(v) - \frac{1}{2}(3p_1 + p_2) \geq d_G(v) - \frac{1}{2}(2d_G(v) - 5) = \frac{5}{2}$. ■

Theorem 2.8. *If G has no isolated edge, and $\text{Mad}(G) < \frac{5}{2}$, then G has a proper 3-weighting.*

Proof. A minimal counterexample contains none of **A–E** in Lemma 2.6. Since it has average degree less than $5/2$, it contains a configuration in Lemma 2.7. The configurations are the same except for **E**. Since a 5^+ -vertex v satisfying $3p_1 + p_2 \geq 2d_G(v) - 4$ also satisfies $3p_1 + 2p_2 \geq d_G(v)$, every graph with $\text{Mad}(G) < 5/2$ contains a 3-reducible configuration. ■

For the 1, 2-Conjecture, we again begin with reducible configurations. Isolated edges are now allowed, which eliminates some technicalities. We will use Lemma 2.7, but the list of 2-reducible configurations is different. In obtaining a proper total 2-weighting of G from such a weighting of a subgraph G' , we may erase weights from some vertices and recolor them.

Configuration **B** in the next lemma is more general than is needed for the 1, 2-Conjecture when $\text{Mad}(G) < 5/2$, but we will need its full generality in the proof for $\text{Mad}(G) < 8/3$.

Lemma 2.9. *The following configurations are 2-reducible.*

- A.** *A 3^- -vertex having a 1-neighbor.*
- B.** *A 4^- -vertex having two 2^- -neighbors.*
- C.** *A 5^+ -vertex v whose number of 2^- -neighbors is at least $(d_G(v) - 1)/2$.*

Proof. In each case, a proper total 2-weighting w' of the derived graph G' yields such a weighting w of G . Let v be the specified vertex. We may assume that a 1-vertex has a 2^+ -neighbor, since isolated edges have proper total 2-weightings. In the extension arguments, we use Lemma 2.3 frequently to choose labels.

Case A: $d_G(v) \leq 3$, and v has a 1-neighbor u . For $d_G(v) = 3$, let $N_{G'}(v) = \{x, x'\}$ (see Figure 4A). Uncolor v , and then choose $w(v), w(uv) \in \{1, 2\}$ to satisfy vx and vx' . Now choose $w(u)$ to satisfy uv . When $d_G(v) = 2$, we only need $w(v) + w(uv)$ to avoid one value.

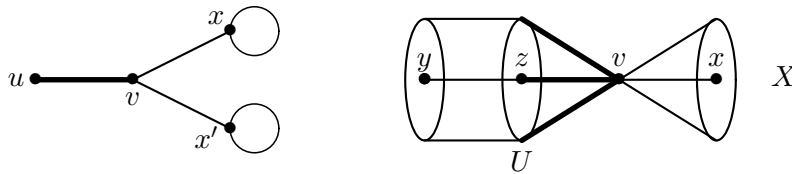

Figure 4. Cases **A** and **C** for Lemma 2.9.

Case C: $d_G(v) \geq 5$ and v has at least $\frac{d_G(v)-1}{2}$ 2^- -neighbors. Let U be a set of p such neighbors, where $p = \lceil \frac{d_G(v)-1}{2} \rceil$, and let $G' = G - [v, U]$ and $X = N_{G'}(v)$. By Lemma 2.2, for $z \in U$ we may assume $d_G(z) = 2$ and let $\{y\} = N_{G'}(z)$ (see Figure 4C). Uncolor all of U . By Lemma 2.3, we can choose the $p + 1$ weights on $\{v\} \cup \{vz: z \in U\}$ to satisfy $[v, X]$ in G , since $p + 1 \geq d_G(v) - p$. Now choose $w(z)$ for $z \in U$ to satisfy zy . Finally, since $d_G(v) \geq 5$, we have $\rho_w(v, z) \geq 5 > 4 \geq w(z) + w(zv)$, so zv is automatically satisfied.

Case B: v has two 2^- -neighbors z and z' . By Lemma 2.2, we may assume $d_G(z) = d_G(z') = 2$. By Lemma 2.5, we may assume $zz' \notin E(G)$. Let $G' = G - \{vz, vz'\}$. Since the edges of G' incident to the core must be satisfied in the extension to G , uncolor v, z , and z' .

Subcase B1: $d_G(v) \in \{3, 4\}$. Let $X = N_G(v) - \{z, z'\}$ (Figure 5). Let $a = \sum_{x \in X} w'(vx)$. If $a \geq 2$, then setting $w(v) = 2$ ensures satisfying vz and vz' .

Using $|X| \leq 2$, choose $w(vz)$ and $w(vz')$ to satisfy $\Gamma_{G'}(v)$. Now choose $w(z)$ and $w(z')$ to satisfy yz and $y'z'$, respectively.

Hence we may assume $a = 1$, which requires $d_G(v) = 3$. If $w'(yz) = 1$, then set $w(vz') = 2$ to ensure satisfying vz . Next choose $w(z')$ to satisfy $z'y'$, and then choose $w(v)$ and $w(vz)$ to satisfy vz' and vx . Finally, choose $w(z)$ to satisfy yz .

By symmetry, we may now assume $a = 1$ and $w'(yz) = w'(y'z') = 2$, as in the middle picture in Figure 5. If $w'(y) = 1$, then we can exchange $w'(y)$ and $w'(yz)$ with no effect on the satisfaction of any edge in $\Gamma_{G'}(y)$ except yz , thereby reaching the case in the preceding paragraph. Hence by symmetry we may also assume $w'(y) = w'(y') = 2$.

Let $b = \rho_{w'}(x, v)$. If $b = 4$, then set $w(zv) = w(v) = w(vz') = 2$ to satisfy vx and ensure satisfying vz and vz' ; then choose $w(z)$ and $w(z')$ to satisfy zy and $z'y'$, respectively. If $b \neq 4$, then set $w(v) = 2$ and $w(z) = w(zv) = w(vz') = w(z') = 1$. By **A**, we have $d_G(y) \geq 2$ and hence $\rho_{w'}(y, z) > 2$, so yz is satisfied (similarly for $y'z'$). These values also satisfy $\Gamma_G(v)$.

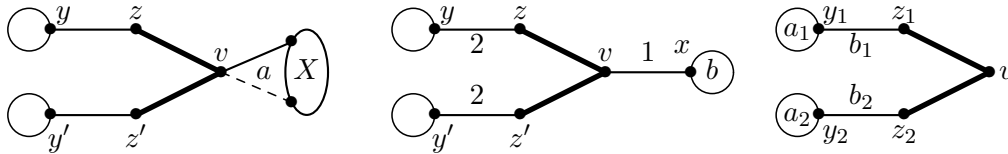

Figure 5. Case **B** for Lemma 2.9

Subcase B2: $d_G(v) = 2$. For this subcase, let $z_1 = z$ and $z_2 = z'$. For $i \in \{1, 2\}$, let $\{y_i\} = N_{G'}(z_i)$, let $b_i = w'(y_i z_i)$, and let $a_i = \rho_{w'}(y_i, z_i)$, as on the right in Figure 5. To satisfy $y_i z_i$, fix $w(vz_i) = 3 - w(z_i)$ when a_i is even and $w(vz_i) = w(z_i)$ when a_i is odd. We then must choose $w(z_1)$ and $w(z_2)$ (and hence $w(vz_1)$ and $w(vz_2)$) to satisfy vz_2 and vz_1 . We need $b_1 + w(z_1) \neq w(v) + w(vz_2)$ and $b_2 + w(z_2) \neq w(v) + w(vz_1)$.

When $a_1 - a_2$ is even, set $w(v) = 1$. When a_1 and a_2 are both even, using $w(vz_i) = 3 - w(z_i)$ converts the requirements to $b_1 + w(z_1) \neq 4 - w(z_2)$ and $b_2 + w(z_2) \neq 4 - w(z_1)$. With two choices for both $w(z_1)$ and $w(z_2)$, we can pick them so that $w(z_1) + w(z_2) \notin \{4 - b_1, 4 - b_2\}$. When a_1 and a_2 are both odd, using $w(vz_i) = w(z_i)$ it suffices to choose $w(z_1), w(z_2) \in \{1, 2\}$ so that $w(z_1) - w(z_2) \notin \{1 - b_1, b_2 - 1\}$. Since the difference can be any of the three values in $\{1, 0, -1\}$, this also can be done.

When a_1 and a_2 have opposite parity, we may let a_1 be even. Now set $w(v) = 3 - b_1$ and $w(z_1) = w(z_2) = b_1$. Using $w(vz_1) = 3 - w(z_1)$ and $w(vz_2) = w(z_2)$, we have satisfied vz_1 because $b_1 + w(z_1) = 2b_1 \neq 3 = w(v) + w(z_2)$, and we have satisfied vz_2 because $b_2 + w(z_2) = b_2 + b_1 \neq 6 - 2b_1 = w(v) + 3 - w(z_1)$. ■

Theorem 2.10. *If $\text{Mad}(G) < 5/2$, then G has a proper total 2-weighting.*

Proof. Since $\bar{d}(G) < 5/2$, in G there is a configuration listed in Lemma 2.7. Configurations **A–D** listed there are all 2-reducible, by **A** and **B** of Lemma 2.9. Hence to show that every graph with $\text{Mad}(G) < 5/2$ contains a 2-reducible configuration, it suffices to show that a 5^+ -vertex v satisfying $3p_1 + p_2 \geq 2d_G(v) - 4$ (**E** of Lemma 2.7) also satisfies $2p_1 + 2p_2 \geq d_G(v) - 1$ (**C** of Lemma 2.9). If the desired inequality fails, then subtracting $2p_1 + 2p_2 \leq d_G(v) - 2$ from the given inequality yields $p_1 \geq d_G(v) - 2$. Since $d_G(v) - 2 \geq (d_G(v) - 1)/2$, the desired inequality holds. ■

3. PROPER TOTAL 2-WEIGHTING WHEN $\text{Mad}(G) < 8/3$

A graph formed by adding a pendant edge at each vertex of a 3-regular graph has average degree $5/2$. It has no configuration in Lemma 2.9, since each 4-vertex has one 1-neighbor and three 4-neighbors. Further 2-reducible configurations will require multiple “almost-reducible” vertices. We introduce two types.

Definition 3.1. A β -vertex is a 3-vertex with exactly one 2-neighbor and no 1-neighbor. A β' -vertex is a $2k$ -vertex, where $k \geq 2$, with no 2-neighbor and exactly $k - 1$ 1-neighbors. For $\gamma \in \{\beta, \beta'\}$, a γ -neighbor of v is a γ -vertex in $N(v)$.

We will show in Lemma 3.4 that various configurations involving such vertices are 2-reducible. Theorem 3.5 shows that these plus the configurations in Lemma 2.9 form an unavoidable set when $\text{Mad}(G) < 8/3$. The argument would be shorter if adjacent β' -vertices of degree 4 formed a reducible configuration, but our usual method fails there.

Example 3.2. Let v and v' be adjacent β' -vertices of degree 4 in G having 1-neighbors u and u' , respectively. As in Section 2, the core F is $\{uv, vv', v'u'\}$, and $G' = G - F$. A total 2-weighting w' of G' may assign labels as indicated in Figure 6. To extend w' , we need $w(uv) + w(v) + w(vv') \in \{3, 6\}$; hence these three weights must be equal. Similarly, $w(u'v') + w(v') + w(vv') \in \{3, 6\}$. Since $w(vv')$ can take only one value, we have forced $\phi_w(v) = \phi_w(v')$. Hence no extension to a proper total 2-weighting is possible.

Another would-be-useful but non-reducible configuration consists of a β -vertex v whose 2-neighbor z has a 2-neighbor y . A total 2-weighting w' of G' may assign labels as indicated in Figure 6. The values of ϕ_w' at the neighbors of v other than z force $w(v) = w(vz) = 1$. Now satisfying vz requires $w(z) = w(vz)$. Similarly, satisfying xy requires $w(y) = w(yz)$. We conclude $w(z) = w(y)$, but now yz cannot be satisfied, since also $w(yz) = w(zv)$. □

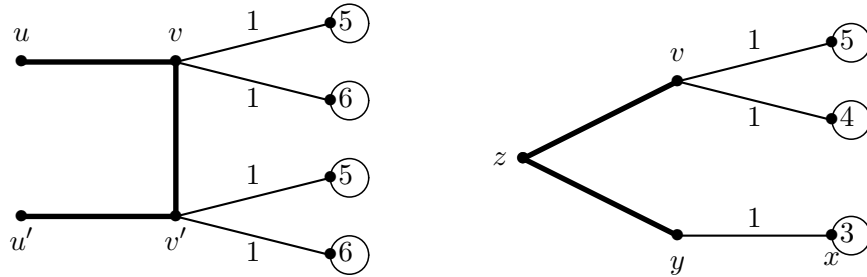

Figure 6. Non-reducible: adjacent β' -vertices, or β -vertex near extra 2-vertex.

Graphs formed by adding a pendant edge at each vertex of a 3-regular graph contain only configuration **F** among those in Lemma 3.4. Although its reducibility proof does not require the full flexibility of choosing weights in it, Example 3.2 shows that the local argument cannot be completed when a β' -vertex has only one β' -neighbor (of degree 4).

Example 3.2 also shows that a β -vertex is not reducible, even when its 2-neighbor has another 2-neighbor. Nevertheless, when a β -vertex appears in a minimal 2-bad graph we can guarantee satisfying all but one specified edge at that vertex. This is useful when we can ensure satisfying that edge, such as when its other endpoint has high degree.

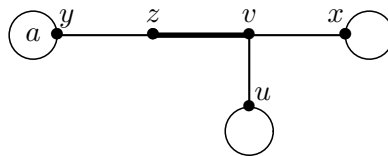

Figure 7. Configuration for Lemma 3.3.

Lemma 3.3. *Let v be a β -vertex with 2-neighbor z in a minimal 2-bad graph G . Let $N_G(v) = \{z, x, u\}$ and $N_G(z) = \{v, y\}$ (see Figure 7). If $G - vz$ has a proper partial 2-weighting w' satisfying $\Gamma_G(x)$ and $\Gamma_G(y)$, then G has a partial 2-weighting w satisfying the same edges other than vu , plus vz , without changing weights on $G - \{v, z\}$ except possibly on yz and y .*

Proof. Let $G' = G - vz$. By Lemma 2.9A, $d(y) \geq 2$. We want to choose $w(v)$, $w(z)$, and $w(vz)$ to satisfy $\{xv, vz, zy\}$, leaving edges other than vu satisfied.

Let $a = \rho_{w'}(y, z)$. If $a \geq 4$, then setting $w(zv) = 1$ ensures satisfying yz , after which we choose $w(v)$ to satisfy vx and $w(z)$ to satisfy vz .

If $a = 3$ and $d_G(y) = 3$, then $w'(y) = 1$ ($y = u$ is allowed). If $w'(yz) = 2$, then we can exchange the weights on y and yz and apply the previous case. If $w'(yz) = 1$, then setting $w(z) = w(zv) = 1$ satisfies both yz and zv , after which we choose $w(v)$ to satisfy vx .

The remaining case is $d_G(y) = 2$; let $N_G(y) = \{z, u'\}$ ($u' = u$ is allowed). Uncolor y and yz . Setting $w(yz) = 1$ and $w(v) = 2$ ensures satisfying zv . Now choose $w(vz)$ to satisfy vx , $w(y)$ to satisfy yu' , and $w(z)$ to satisfy yz . ■

Lemma 3.4. *The following configurations are 2-reducible.*

- A.** *A 3^- -vertex having a 1-neighbor.*
- B.** *A 4^- -vertex having two 2^- -neighbors.*
- C.** *A 5^+ -vertex v whose number of 2^- -neighbors is at least $(d_G(v) - 1)/2$.*
- D.** *Two adjacent β -vertices.*
- E.** *A β -vertex with a β' -neighbor.*
- F.** *A β' -vertex of degree 4 having two β' -neighbors of degree 4.*
- G.** *A 3-vertex where each neighbor is a β -vertex or is a β' -vertex of degree 4.*

Proof. Configurations **A–C** were shown to be 2-reducible in Lemma 2.9. For **D–G**, as usual we consider a minimal 2-bad graph G containing the specified configuration, and the derived graph G' is obtained by deleting the core, shown in bold in Figures 8–10. In each case we have a proper total 2-weighting w' of G' and produce a proper total 2-weighting w of G by choosing weights on the deleted edges and on their endpoints, leaving all other weights as in w' , with the possible exception of applying Lemma 3.3. For each successive configuration, we know that the earlier configurations do not occur in G .

Case D: *v and v' are adjacent β -vertices.* As shown in Figure 8**D**, v and v' have degree 3, with 2-neighbors z and z' , respectively. Let $N_G(v) = \{z, v', x\}$ and $N_G(v') = \{z', v, x'\}$, also $N_G(z) = \{v, y\}$ and $N_G(z') = \{v, y'\}$ ($y = y'$ and/or $x = x'$ are allowed in the argument). By Lemma 2.5, we may assume $z \neq z'$, $y \neq x$, and $y' \neq x'$. Let $G' = G - \{zv, vv', v'z'\}$.

Consider first the degenerate case $zz' \in E(G)$, so $y = z'$ and $y' = z$. This also handles the case $y = x'$ or $y' = x$ under appropriate relabeling. Set $w(zz') = 1$ and $w(vv') = 2$ to ensure satisfying zv and $z'v'$. Set $w(z) = w(zv) = 2$. Now choose $w(v)$ to satisfy zv , choose $w(v')$ and $w(v'z')$ to satisfy vv' and $v'x'$, and choose $w(z')$ to satisfy zz' .

Hence we may assume that the vertices are distinct as on the left in Figure 8**D**. Let $a = w'(zy)$, $b = \rho_{w'}(y, z)$, $c = w'(vx)$, and $d = \rho_{w'}(x, v)$. Define a', b', c', d' analogously using y', z', v', x' . In all subcases, set $w(vv') = 2$.

Subcase D1: $d_G(y) = 2$ (or $d_G(y') = 2$). Let $N_G(y) = \{z, u\}$. Uncolor u and yu . Treat $y = z'$ (which implies $u = v'$) as a special case. When $y = z'$,

set $w(zz') = w(z') = 1$; in general, set $w(z) = w(z') = 1$. In both cases, this ensures satisfying vz and $v'z'$ (since $w(vv') = 2$). Now set $w(v'z') = 1$ when $y = z'$, otherwise choose $w(v'z')$ to satisfy $y'z'$. In both cases, next choose $w(v')$ to satisfy $v'x'$, then $w(v)$ and $w(vz)$ to satisfy vv' and vx . Finally, choose $w(z)$ to satisfy zz' when $y = z'$, otherwise, choose $w(u)$ to satisfy yu and then $w(yu)$ to satisfy the other edge at u .

Subcase D2: $d_G(y) \neq 2$. By $\overline{\mathbf{A}}$, we may assume $d(y) \geq 3$. If $c = 2$ or $a = 1$, then $w(vv') = 2$ ensures satisfying zv . Set $w(v') = 2$ to guarantee satisfying $z'v'$. Now choose $w(z'v')$ to satisfy $v'x'$, and choose $w(z')$ to satisfy $z'y'$. Next choose $w(zv)$ and $w(v)$ to satisfy vx and vv' . Finally, choose $w(z)$ to satisfy zy .

We may therefore assume $c = 1$ and $a = 2$, and by symmetry $c' = 1$ and $a' = 2$. We may also assume $w'(y) = w'(y') = 2$, since otherwise we can switch weights on y and yz (or on y' and $y'z'$), which leaves the other edges at y or y' satisfied and yields the subcase above.

With $d_G(y) \geq 3$, we have $b \geq 4$ (since $w'(y) = 2$). By symmetry, $d_G(y') \geq 3$ and $b' \geq 4$. Now setting $w(z) = w(z') = 1$ ensures satisfying $\Gamma_G(z)$ and $\Gamma_G(z')$ (since $w(vv') = 2$). Finally, choose $w(zv) + w(v)$ to avoid $d - 2$ and $w(z'v') + w(v')$ to avoid $d' - 2$ (allowing two choices for each sum) so that the sums are different. This satisfies vx , $v'x'$, and vv' .

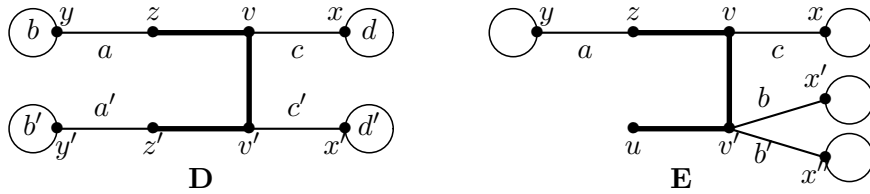

Figure 8. Cases **D** and **E** for Lemma 3.4.

Case E: v is a β -vertex with a β' -neighbor v' . Let $N_G(v) = \{x, z, v'\}$ with $N_G(z) = \{y, v\}$. If $d_G(v') \geq 6$, then let U be the set of 1-neighbors of v' . Set $w(v') = 2$ to guarantee satisfying vv' (since now $\rho_w(v', v) \geq 7 > 6 \geq \rho_w(v, v')$). Including vv' , there remain $|\{v', N_G(v') - U\}|$ edges incident to v' with unchosen weights; by Lemma 2.3, we can choose them to satisfy $[v', N_G(v') - U]$. The edges of $[v, U]$ are automatically satisfied. Finally, with $w(vv')$ chosen, Lemma 3.3 allows us to complete w to a proper 2-weighting of G .

We may therefore assume $d_G(v') = 4$, as in Figure 8**E**, with 1-neighbor u . Let $G' = G - \{zv, vv', v'u\}$, leaving $v'x', v'x'' \in E(G')$. Let $a = w'(zy)$, $b = w'(v'x')$, $b' = w'(v'x'')$, and $c = w'(vx)$. The argument allows $y \in \{x', x''\}$. Fix $w(u) = 1$.

If $b + b' - c \geq 2$, then requiring $w(v) + w(zv) = 3$ guarantees satisfying $v'v$. Choose $w(v'v)$ to satisfy vx , and choose $w(v')$ and $w(v'u)$ to satisfy $v'x'$ and $v'x''$. With $w(v) = 3 - w(zv)$, there are three choices for $w(zv) + w(z)$,

so we can choose $w(zv)$ and $w(z)$ with $w(z) + w(zv) \neq \rho_{w'}(y, z)$ to satisfy yz and $w(z) + a \neq 3 - w(zv) + c + w(vv')$ to satisfy zv . We may therefore assume $b + b' - c \leq 1$.

If $c = 2$ or $a = 1$, then requiring $w(v) + w(vv') = 3$ guarantees satisfying zv . Now choose $w(zv)$ to satisfy vx and then $w(z)$ to satisfy zy . Finally, tentatively set $w(vv') = 2$ and $w(v) = 1$, and then choose $w(v')$ and $w(v'u)$ to satisfy $v'x'$ and $v'x''$. If vv' is not now satisfied, then $w(v') + w(v'u) < 4$. Now exchange weights on vv' and v while increasing $w(v')$ or $w(v'u)$ to satisfy vv' and preserve the satisfaction of $v'x'$ and $v'x''$.

Hence we may assume $c = 1$ and $a = 2$. Since also $b + b' - c \leq 1$, we have $b = b' = 1$. Tentatively set $w(v'u) = 2$, and choose $w(v')$ and $w(vv')$ to satisfy $v'x'$ and $v'x''$, with $w(v') \geq w(vv')$. If $w(v') = 2$, then vv' is automatically satisfied (since $c = 1$), and Lemma 3.3 completes the extension to w . If $w(v') = 1$ and the application of Lemma 3.3 produces $w(zv) = w(v) = 2$, then vv' is not satisfied. In this case, $\rho_{w'}(x', v'), \rho_{w'}(x'', v') = \{6, 7\}$, and changing $w(v'u)$ to 1 satisfies vv' while still satisfying $v'x'$ and $v'x''$.

Case F: v is a β' -vertex of degree 4 with β' -neighbors z and z' of degree 4. Let $N_G(v) = \{x, u, z, z'\}$. Let u, y, y' be the 1-neighbors of v, z, z' (see Figure 9).

Subcase F1: $zz' \in E(G)$. Here we have a triangle of β' -vertices with degree 4. Let $G' = G - \{vz, vz', zz', vu, zy, z'y'\}$. Let t and t' be the remaining neighbors of z and z' , respectively. By symmetry, the only cases are $w'(zt) \neq w'(z't')$ or $w'(zt) = w'(z't') = w'(vx) = c$.

If $w'(zt) \neq w'(z't')$, then by symmetry we may assume $w'(zt) = 1$ and $w'(z't') = 2$. Set $w(zz') = w(z') = w(z'v) = 2$ and $w(zv) = w(v) = 1$ to ensure satisfying zz' and $z'v$. Now choose $w(vu)$ to satisfy $\Gamma_{G'}(v)$ and choose $w(z'y')$ to satisfy $\Gamma_{G'}(z')$. Finally, choose $w(z)$ and $w(zy)$ to satisfy zv and $\Gamma_{G'}(z)$.

In the other case, let $w(vu) = w(v) = w(vz) = w(vz') = a$. Choose a to satisfy vx . Let $w(zz') = 3 - a$ to ensure satisfying vz and vz' . With $w(z')$ arbitrary, choose $w(z'y')$ to satisfy $z't'$. Then choose $w(z)$ and $w(zy)$ to satisfy zz' and zt .

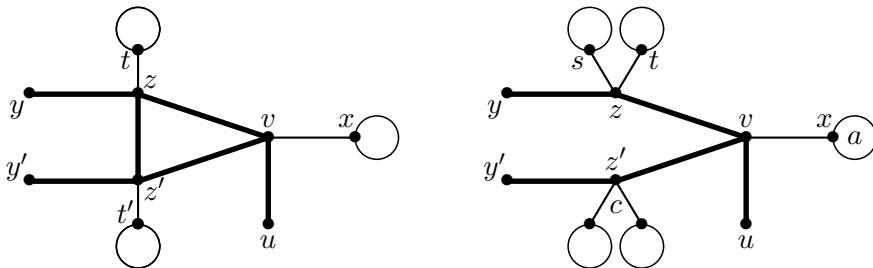

Figure 9. Cases **F1** and **F2** for Lemma 3.4.

Subcase F2: $zz' \notin E(G)$. Let $G' = G - \{yz, zv, vu, vz', z'y'\}$. Let $a = \rho_{w'}(x, v)$. If $a \neq 6$, then requiring $w(v) + w(vz') = 3$ and $w(vz) + w(vu) = 3$ satisfies xv , with $w(vz')$ and $w(vz)$ still choosable freely. Choose $w(z'y)$, $w(z)$, and $w(vz)$ so that their sum avoids $\{\rho_{w'}(s, z), \rho_{w'}(t, z)\}$, where $\{s, t\} = N_{G'}(z)$, and so that $w(z'y) + w(z) + w'(sz) + w'(tz) \neq 3 - w(vz) + w(v) + w(vz') + w'(vx)$ (to satisfy vz). Since $w(v) + w(vz') = 3$, there are three constants for $w(z'y) + w(z) + w(vz)$ to avoid, so such a choice exists. Finally, choose $w(vz')$, $w(z')$, and $w(z'y')$ to satisfy vz and $\Gamma_{G'}(z)$, again making their sum avoid three known values.

Hence we may assume $a = 6$. Now choosing $w(v) = w(vu) = w(vz)$ guarantees satisfying xv . Let b denote the value to be chosen for them. Let c be the total weight assigned by w' to $\Gamma_{G'}(z')$. If $c = 2$, or if $c = 3$ and $w(vx) = 2$, then let $b = 2$. Otherwise, let $b = 1$. In either case, vz' is guaranteed to be satisfied. Finally, choose $w(z)$ and $w(z'y)$ to satisfy zs and zt , choose $w(vz')$ to satisfy vz , and choose $w(z')$ and $w(z'y')$ to satisfy $\Gamma_{G'}(z')$.

Case G: v is a 3-vertex with neighbors z_1, z_2, z_3 (where $d_G(z_1) \geq d_G(z_2) \geq d_G(z_3)$) such that each is a β -vertex or is a β' -vertex of degree 4. For $i \in \{1, 2, 3\}$, let y_i be the neighbor of z_i with degree $5 - d_G(z_i)$. When $d_G(z_i) = 3$, let x_i be the other neighbor of z_i and let y'_i be the other neighbor of y_i . When $d_G(z_i) = 4$, let $\{x_i, x'_i\} = N_G(z_i) - \{v, y_i\}$.

We first reduce to the case where $N_G(v)$ is independent. Adjacent β -vertices are forbidden by $\overline{\mathbf{D}}$. Adjacent β - and β' -vertices are forbidden by $\overline{\mathbf{E}}$.

The third possibility is that z and z' are adjacent β' -vertices having a common 3-neighbor v . The situation is illustrated by deleting u from the left graph in Figure 9. Label the vertices as described there, with $G' = G - \{vz, vz', zz', zy, z'y'\}$. If $w'(zt) = 2$ or $w'(vx) = 1$, then set $w(vz) = w(vz') = 1$ and $w(z') = w(zz') = 2$ to ensure satisfying vz and vz' . Choose $w(v)$ to satisfy xv , choose $w(z'y')$ to satisfy $z't'$, and choose $w(z)$ and $w(zy)$ to satisfy zt and zz' .

By symmetry, we may now assume $w'(zt) = w'(z't') = 1$ and $w'(vx) = 2$. Also, $w'(x) = 2$, or we can switch the weights on x and vx to reach the case just discussed. Now, using $d_G(x) \geq 3$ (since x is a β - or β' -neighbor of v), we have $\rho_{w'}(x, v) \geq 4$. Now set $w(zv) = w(v) = w(vz') = 1$ and $w(zz') = 2$ to satisfy xv and ensure satisfying vz and vz' . Finally, set $w(z') = 1$, choose $w(z'y')$ to satisfy $z't'$, and choose $w(z)$ and $w(zy)$ to satisfy zt and zz' .

Hence we may assume that $N_G(v)$ is independent. If two β -vertices in $N_G(v)$ have a common 2-neighbor, say z_1 and z_2 with common 2-neighbor y , then let $G' = G - \{vz_1, vz_2, z_1y, z_2y\}$. Set $w(vz_1) = w(vz_2) = 2$ and $w(y) = 1$ to ensure satisfying z_1y and z_2y . Now choose $w(v)$ to satisfy vz_3 , choose $w(z_1)$ and $w(z_1y)$ to satisfy vz_1 and $\Gamma_{G'}(z_1)$, and choose $w(z_2)$ and $w(z_2y)$ to satisfy vz_2 and $\Gamma_{G'}(z_2)$.

Now $N_G(v)$ is independent and the 2-neighbors of β -neighbors of v are distinct. The remaining cases are shown in Figure 10. The argument does not require the vertices on circles to be distinct. Let Subcase j be the situation

where j neighbors of v are β' -vertices. In each subcase, the deleted core consists of $\Gamma_G(v)$ and $\{z_1y_1, z_2y_2, z_3y_3\}$. To obtain w from w' , we must satisfy these six edges and six additional edges incident to them. We have the freedom to choose weights on the six deleted edges and their seven incident vertices.

We define operation S_i to satisfy the edges in the i th “branch” when $w(vz_i)$ has been specified. If $d_G(z_i) = 3$, then S_i uses Lemma 3.3 to choose $w(z_i)$, $w(z_iy_i)$, and $w(y_i)$ (plus possible changes to weights on $y_iy'_i$ and y'_i but not on z_ix_i or z_iv) so that z_ix_i , z_iy_i , and $y_iy'_i$ become satisfied. If $d_G(z_i) = 4$, then S_i chooses $w(z_i)$ and $w(z_iy_i)$ to satisfy z_ix_i and $z_ix'_i$. (When $d_G(z_i) = 4$, automatically z_iy_i is satisfied, and $w(y_i)$ is irrelevant.)

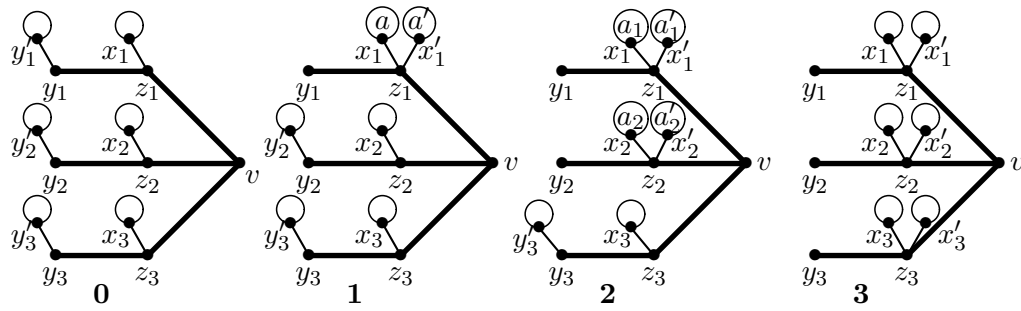

Figure 10. Case **G** for Lemma 3.4.

Subcase G0: Set $w(v) = w(vz_1) = w(vz_2) = w(vz_3) = 2$, and consider $i \in \{1, 2, 3\}$. If $w'(x_iz_i) = 1$, then z_iv is automatically satisfied; apply S_i . If $w'(x_iz_i) = 2$, then z_iy_i is automatically satisfied. Set $w(z_i) = 1$ to satisfy z_iv . Choose $w(z_iy_i)$ to satisfy z_ix_i , and choose $w(y_i)$ to satisfy $y_iy'_i$.

Subcase G1: Let $a = \rho_{w'}(x_1, z_1)$ and $a' = \rho_{w'}(x'_1, z_1)$. When $w'(z_1x_1) = w'(z_1x'_1) = 1$ and $\{a, a'\} = \{6, 7\}$, set $w(z_3v) = w(z_2v) = 2$. Otherwise, set $w(z_3v) = w(z_2v) = 1$. With $w(z_3v)$ and $w(z_2v)$ fixed, apply S_2 and S_3 . Now choose $w(v)$ and $w(vz_1)$ to satisfy vz_2 and vz_3 , with $w(v) \leq w(vz_1)$.

If we have set $w(z_3v) = w(z_2v) = 2$, then $w'(z_1x_1) = w'(z_1x'_1) = 1$; satisfy vz_1 by setting $w(z_1) = w(z_1y_1) = 1$. Since $\{a, a'\} = \{6, 7\}$, this also satisfies $\Gamma_{G'}(z_1)$.

If we have set $w(z_3v) = w(z_2v) = 1$, then $w'(z_1x_1) + w'(z_1x'_1) \geq 3$ or $\{a, a'\} \neq \{6, 7\}$. In the first case, vz_1 is automatically satisfied; apply S_1 . In the second, $w(z_3v) = w(z_2v) = w'(z_1x_1) = w'(z_1x'_1) = 1$ and $\{a, a'\} \neq \{6, 7\}$; choose $b \in \{6, 7\} - \{a, a'\}$. If $w(v) = 1$, then vz_1 is automatically satisfied; apply S_1 . Otherwise, $w(v) = w(vz_1) = 2$, since we chose $w(v) \leq w(vz_1)$. Now choose $w(z_1)$ and $w(z_1y_1)$ with sum $b - 3$. This satisfies vz_1 and $\Gamma_{G'}(z_1)$.

Subcase G2: Set $w(z_3v) = 1$ and apply S_3 . If $w'(z_1x_1) = 2$, then $w(z_1v) = w(v) = 1$ ensures satisfying z_1v and z_2v ; choose $w(z_2v)$ to satisfy vz_3 and apply S_1

and S_2 . By symmetry, we may thus assume $w'(z_i x_i) = w'(z_i x'_i) = 1$ for $i \in \{1, 2\}$. If $w(z_3) + w'(z_3 x_3) + w(z_3 y_3) > 3$, then setting $w(v) = w(vz_2) = w(vz_1) = 1$ satisfies vz_3 and ensures satisfying vz_2 and vz_1 ; apply S_2 and S_1 . Hence we may also assume $w(z_3) + w'(z_3 x_3) + w(z_3 y_3) = 3$. Let $a_i = \rho_{w'}(x_i, z_i)$ and $a'_i = \rho_{w'}(x'_i, z_i)$, for $i \in \{1, 2\}$.

If $\{a_1, a'_1\} \neq \{5, 6\}$, then set $w(vz_1) = w(v) = 1$ and $w(vz_2) = 2$. Now vz_3 is satisfied and vz_2 is automatically satisfied; apply S_2 . Choose $b \in \{5, 6\} - \{a_1, a'_1\}$. Choose $w(z_1)$ and $w(z_1 y_1)$ summing to $b - 2$. This satisfies vz_1 and $\Gamma_{G'}(z_1)$.

By symmetry, we may thus assume $\{a_1, a'_1\} = \{a_2, a'_2\} = \{5, 6\}$. Let $w(v) = 2$ and $w(vz_i) = w(z_i) = w(z_i y_i) = 2$ for $i \in \{1, 2\}$ to satisfy all remaining edges.

Subcase G3: Set $w(v) = w(vz_1) = w(vz_2) = w(vz_3) = 1$ to guarantee satisfying each vz_i . Now for each i choose $w(y_i z_i)$ and $w(z_i)$ to satisfy $z_i x_i$ and $z_i x'_i$. ■

Case **F** and Case **G** in Lemma 3.4 can be generalized. If v in Case **F** or z_i in Case **G** is a β' -vertex of any even degree, then the configuration remains 2-reducible. We omit this since it is not needed to prove the 1, 2-Conjecture for $\text{Mad}(G) < 8/3$. The more restrictive configurations in the lemma complete an unavoidable set.

Lemma 3.5. *If $\bar{d}(G) < 8/3$, then G contains one of the following configurations.*

- A.** *A 3^- -vertex having a 1-neighbor.*
- B.** *A 4^- -vertex having two 2^- -neighbors.*
- C.** *A 5^+ -vertex v whose number of 2^- -neighbors is at least $(d_G(v) - 1)/2$.*
- D.** *Two adjacent β -vertices.*
- E.** *A β -vertex with a β' -neighbor.*
- F.** *A β' -vertex of degree 4 having two β' -neighbors of degree 4.*
- G.** *A 3-vertex where each neighbor is a β -vertex or is a β' -vertex of degree 4.*

Proof. We prove that avoiding **A–G** requires $\bar{d}(G) \geq 8/3$. Give each $v \in V(G)$ initial charge $d_G(v)$. Move charge via the following rules:

- (R1) Each 1-vertex takes $\frac{5}{3}$ from its neighbor.
- (R2) Each 2-vertex takes $\frac{2}{3}$ from one 3^+ -neighbor.
- (R3) Each 3-vertex with a 2-neighbor takes $\frac{1}{6}$ from each other neighbor.
- (R4) Each 4-vertex with a 1-neighbor takes $\frac{1}{6}$ from each other neighbor there is not a β' -vertex.

Let $\mu(v)$ denote the resulting charge at v . It suffices to check that $\mu(v) \geq \frac{8}{3}$ for all v . For $\mathbf{Z} \in \{\mathbf{A}, \dots, \mathbf{G}\}$, let $\bar{\mathbf{Z}}$ mean “configuration \mathbf{Z} does not occur in G ”. Note that by $\bar{\mathbf{B}}$, the vertex taking charge in (R3) or (R4) is a β -vertex or a β' -vertex, respectively.

Case $d_G(v) = 1$. By (R1), v receives $\frac{5}{3}$ and has final charge $\frac{8}{3}$.

Case $d_G(v) = 2$. By $\overline{\mathbf{A}}$ and $\overline{\mathbf{B}}$, v loses nothing and gets $\frac{2}{3}$ from a 3^+ -neighbor.

Case $d_G(v) = 3$. By $\overline{\mathbf{A}}$, v has no 1-neighbor. If v also has no 2-neighbor, then by $\overline{\mathbf{G}}$ at most two neighbors take charge $\frac{1}{6}$ from it, so $\mu(v) \geq \frac{8}{3}$. If v has a 2-neighbor, then by $\overline{\mathbf{B}}$ it is a β -vertex, has only one 2-neighbor, and may give $\frac{2}{3}$ to that 2-neighbor. By $\overline{\mathbf{D}}$ and $\overline{\mathbf{E}}$, v loses no other charge. If v does lose $\frac{2}{3}$, then v needs to regain $\frac{1}{3}$ and does so by (R3).

Case $d_G(v) = 4$. By $\overline{\mathbf{B}}$, v has at most one 2^- -neighbor. If v has no 1-neighbor, then v loses at most $\frac{2}{3} + \frac{3}{6}$. Hence in this case $\mu(v) > \frac{8}{3}$. If v has a 1-neighbor, then v loses $\frac{5}{3}$ to it and is a β' -vertex. By $\overline{\mathbf{E}}$ and $\overline{\mathbf{F}}$, v has no β -neighbor and at most one β' -neighbor. Hence it gives away no other charge and receives at least $\frac{2}{6}$ to reach $\mu(v) \geq \frac{8}{3}$.

Case $d_G(v) \geq 5$. By $\overline{\mathbf{C}}$, v has at most $\frac{d_G(v)-2}{2}$ 2^- -neighbors. With strict inequality, v gives at most $\frac{5}{3} \frac{d_G(v)-3}{2}$ to them and at most $\frac{1}{6}$ to other neighbors, so

$$\mu(v) \geq d_G(v) - \frac{5}{3} \frac{d_G(v) - 3}{2} - \frac{1}{6} \frac{d_G(v) + 3}{2} = \frac{d_G(v)}{12} + \frac{9}{4} \geq \frac{32}{12} = \frac{8}{3}.$$

If v has exactly $\frac{d_G(v)-2}{2}$ 2^- -neighbors, including a 2-neighbor, then $d_G(v) \geq 6$ and

$$\mu(v) \geq d_G(v) - \frac{5}{3} \frac{d_G(v) - 4}{2} - \frac{2}{3} - \frac{1}{6} \frac{d_G(v) + 2}{2} = \frac{d_G(v)}{12} + \frac{8}{3} - \frac{1}{6} > \frac{8}{3}.$$

In the remaining case, v is a β' -vertex with degree at least 6. By definition, v has $\frac{d_G(v)-2}{2}$ 1-neighbors and no 2-neighbor. By $\overline{\mathbf{E}}$, v has no β -neighbor. By (R3) and (R4), v gives charge only to its 1-neighbors. Hence

$$\mu(v) \geq d_G(v) - \frac{5}{3} \frac{d_G(v) - 2}{2} = \frac{d_G(v)}{6} + \frac{5}{3} \geq \frac{8}{3}. \quad \blacksquare$$

Theorem 3.6. *Every graph G with $\text{Mad}(G) < 8/3$ has a proper total 2-weighting.*

Proof. Every configuration in Lemma 3.5 is 2-reducible. ■

4. PROPER 3-WEIGHTING WHEN $\text{Mad}(G) < 8/3$

For the discussion of proper 3-weightings, again it will be helpful to have notation for special types of vertices. The definition of β -vertex is the same as before, but instead of β' -vertices we introduce α -vertices and γ -vertices.

Definition 4.1. An α -vertex is a 2-vertex with a 2-neighbor. A β -vertex is a 3-vertex with a 2-neighbor. A γ -vertex is a 4-vertex with a 1-neighbor or is a 3-vertex with an α -neighbor or two 2-neighbors.

Lemma 4.2. *If $\bar{d}(G) < 8/3$, then G contains one of the following configurations.*

- A.** *A 2-vertex or 3-vertex having a 1-neighbor.*
- B.** *A 4^- -vertex whose neighbors all have degree 2.*
- C.** *A 3-vertex having an α -neighbor and another 2-neighbor.*
- D.** *A 4-vertex having a 1-neighbor and a 2^- -neighbor.*
- E.** *A 5^+ -vertex v with $3p_1 + 2p_2 \geq d_G(v)$, where v has p_i i -neighbors.*
- F.** *Two adjacent γ -vertices.*
- G.** *A 3-vertex with two γ -neighbors.*
- H.** *A 6-vertex or 7-vertex having a 1-neighbor and four γ -neighbors.*
- I.** *A 5-vertex having a 1-neighbor and three γ -neighbors.*
- J.** *A 4-vertex v with $p + q + r \geq 5$, where v has p 2-neighbors, q γ -neighbors, and r α -neighbors.*
- K.** *A γ -vertex whose 3^+ -neighbors are all β -vertices.*

Proof. We prove that avoiding **A–K** requires $\bar{d}(G) \geq 8/3$. Give each $v \in V(G)$ initial charge $d_G(v)$. Move charge via the following rules:

- (R1) Each 1-vertex takes $\frac{5}{3}$ from its neighbor.
- (R2) Each α -vertex takes $\frac{2}{3}$ from its 3^+ -neighbor.
- (R3) Each 2-vertex that is not an α -vertex takes $\frac{1}{3}$ from each neighbor.
- (R4) Each γ -vertex takes $\frac{1}{3}$ from each 3^+ -neighbor that is not a β -vertex.

Let $\mu(v)$ denote the resulting charge at v . It suffices to check that $\mu(v) \geq \frac{8}{3}$ for all v . For $\mathbf{Z} \in \{\mathbf{A}, \dots, \mathbf{K}\}$, let $\bar{\mathbf{Z}}$ mean “configuration \mathbf{Z} does not occur in G ”. Let a fixed vertex v have p_i i -neighbors, q γ -neighbors, and r α -neighbors.

Case $d_G(v) = 1$. By (R1) v receives $\frac{5}{3}$ and has final charge $\frac{8}{3}$.

Case $d_G(v) = 2$. By $\bar{\mathbf{A}}$, v gives no charge, and by (R2) or (R3), v receives $\frac{2}{3}$.

Case $d_G(v) = 3$. By $\bar{\mathbf{A}}$ and $\bar{\mathbf{B}}$, v has no 1-neighbor and at most two 2-neighbors. If no 2-neighbor, then v is not a γ -vertex or a β -vertex, loses nothing by (R2) or (R3), and gives $\frac{1}{3}$ to a γ -neighbor by (R4). By $\bar{\mathbf{G}}$, v loses at most $\frac{1}{3}$, and $\mu(v) \geq \frac{8}{3}$.

If v has a 2-neighbor, then v is a β -vertex, and (R4) does nothing. By $\bar{\mathbf{B}}$ and $\bar{\mathbf{C}}$, v gives at most $\frac{2}{3}$ to 2-neighbors, with equality only if v is a γ -vertex. If so, then v has a 3^+ -neighbor, by $\bar{\mathbf{A}}$ and $\bar{\mathbf{B}}$. By $\bar{\mathbf{F}}$, v is not a γ -vertex, and by $\bar{\mathbf{K}}$ not all 3^+ -neighbors are β -vertices. Hence v gets $\frac{1}{3}$ from some 3^+ -neighbor, and $\mu(v) \geq \frac{8}{3}$.

Case $d_G(v) = 4$. If v has a 1-neighbor, then v is a γ -vertex. It has no other 2^- -neighbor ($\bar{\mathbf{D}}$) and loses at most $\frac{5}{3}$. Other neighbors are 3^+ -vertices, none is a γ -vertex ($\bar{\mathbf{F}}$), and not all are β -vertices ($\bar{\mathbf{K}}$). With at least $\frac{1}{3}$ from (R4), $\mu(v) \geq \frac{8}{3}$.

If v has no 1-neighbor, then v is not a γ -vertex. By $\bar{\mathbf{J}}$, $p+q+r \leq 4$. An α -neighbor counts for both p and r , so v loses exactly $(p+q+r)/3$, and $\mu(v) \geq \frac{8}{3}$.

Case $d_G(v) \geq 5$. The lost charge is $\frac{1}{3}(5p_1 + p_2 + q + r)$, so v is happy if $5p_1 + p_2 + q + r \leq 3d_G(v) - 8$. Configurations with $3p_1 + 2p_2 \geq d_G(v)$ are forbidden ($\bar{\mathbf{E}}$). Hence if v is not happy and is not in a configuration forbidden by $\bar{\mathbf{E}}$, then

$$(1) \quad 5p_1 + p_2 + q + r \geq 3d_G(v) - 7 \quad \text{and} \quad 3p_1 + 2p_2 \leq d_G(v) - 1.$$

Since $r \leq p_2$ and $q \leq d_G(v) - p_1$, the first inequality above yields $4p_1 + 2p_2 \geq 2d(v) - 7$. Eliminating $2p_2$ from the two inequalities then yields $2d(v) - 7 - 4p_1 \leq d_G(v) - 1 - 3p_1$, which simplifies to $d_G(v) - 6 \leq p_1$. Since also $p_1 \leq \lfloor (d_G(v) - 1)/3 \rfloor$, we obtain $d_G(v) \leq 8$.

If $p_1 = 0$, then substituting $q + r \leq d_G(v)$ in (1) yields $(d_G(v) - 1)/2 \geq 2d(v) - 7$, which simplifies to $d_G(v) \leq 13/3$. Hence we may assume $p_1 \geq 1$. We consider below the remaining unexcluded possibilities for (p_1, p_2, r, q) . In each case these are the choices allowed by (1).

For $d_G(v) = 5$, the remaining case is $(1, 0, 0, q)$ with $q \in \{3, 4\}$, forbidden by $\bar{\mathbf{I}}$.

For $d_G(v) = 6$, the remaining case is $(1, 1, 1, 4)$, forbidden by $\bar{\mathbf{H}}$.

For $d_G(v) = 7$, the case $(1, p_2, r, q)$ requires $p_2 \leq 1$, which yields $5p_1 + 2p_2 + q \leq 12 < 14$, so v remains happy. Hence the remaining case is $(2, 0, 0, q)$ with $q \in \{4, 5\}$, forbidden by $\bar{\mathbf{H}}$.

For $d_G(v) = 8$, with $p_1 \leq 2$ and $3p_1 + 2p_2 \leq 7$, we have $5p_1 + 2p_2 \leq 10$. At most $16/3$ is lost, and hence $\mu(v) \geq \frac{8}{3}$. ■

The next lemma explains the role of γ -vertices.

Lemma 4.3. *For a γ -vertex v with a 3^+ -neighbor x , define $F \subseteq E(G)$ as follows:*

- $F = \{vu\}$ if v is a 4-vertex with 1-neighbor u ,
- $F = \{vz, vz'\}$ if v is a 3-vertex with 2-neighbors z and z' ,
- $F = \Gamma_G(z)$ if v is a 3-vertex with α -neighbor z .

Given any weighting of $G - F$, weights in $\{1, 2, 3\}$ can be chosen on F to satisfy all edges in or incident to F except vx , without changing weights on $G - F$.

Proof. Figure 11 shows F in bold; the weight on vx is fixed. When v is a 4-vertex, choose $w(vu)$ to satisfy the two edges from v to $N_G(v) - \{x, u\}$. When v is a 3-vertex with 2-neighbors z and z' having neighbors y and y' other than v , choose $w(vz)$ to satisfy vz' and zy , and choose $w(vz')$ to satisfy vz and $z'y'$. When v is a 3-vertex with α -neighbor z having neighbor y other than v , let x' and y' be the remaining neighbors of v and y . Choose $w(vz)$ to satisfy vx' and zy , and choose $w(vy')$ to satisfy vz and yy' . ■

In employing Lemma 4.3, the difficulty is ensuring that the edge vx will be satisfied. Generally, we will need to ensure that some edge is satisfied regardless

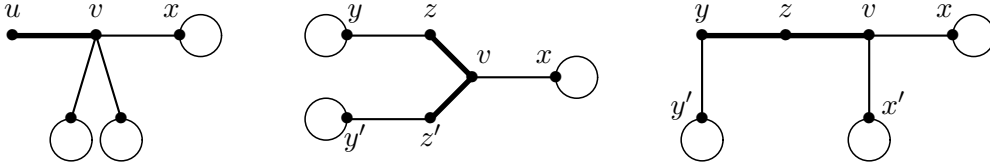

Figure 11. Three cases for Lemma 4.3, with F in bold.

of the choice of weight on some incident edge. When v is a γ -vertex, let F_v denote the set of one or two edges designated as F in Lemma 4.3 (bold in Figure 11).

Like Lemma 2.5, the next lemma excludes degenerate cases later.

Lemma 4.4. *Let z and z' be β -vertices having respective 2-neighbors y and y' that are equal or adjacent. The following cases lead to 3-reducible configurations.*

- (1) $zz' \in E(G)$.
- (2) z and z' have a common neighbor v with a 1-neighbor u and $d_G(v) \in \{4, 5\}$.

Proof. See Figure 12 for these cases.

(1) $zz' \in E(G)$. If $y = y'$, then Lemma 2.5 applies. If $yy' \in E(G)$, then let $G' = G - \{zz', zy, yy', z'y'\}$. Set $w(yy') = 1$ to ensure satisfying zy and $z'y'$. Set $w(zy) = 1$. Choose $w(z'y')$ to satisfy yy' and zz' , and choose $w(zz')$ to satisfy zx and $z'x'$, where $N_G(z) = \{z', y, x\}$ and $N_G(z') = \{z, y', x'\}$ (possibly $x = x'$).

(2) By (1), we may assume $zz' \notin E(G)$, so $x \neq z'$ and $x' \neq z$.

(2a) If $y = y'$, then let $G' = G - \{vz, vz', zy, z'y', vu\}$. Set $w(zy) = w(z'y') = 1$ to ensure satisfying zy and $z'y'$. Choose $w(zv) \in \{2, 3\}$ to satisfy zx and choose $w(z'v) \in \{2, 3\}$ to satisfy $z'x'$. To ensure satisfying vz and vz' , choose $w(vu)$ to satisfy $\Gamma_{G'}(v)$ (if $d_G(v) = 5$) or $w(vu) \in \{2, 3\}$ to satisfy $\Gamma_{G'}(v)$ (if $d_G(v) = 4$).

(2b) If $yy' \in E(G)$, then let $G' = G - \{vz, vz', zy, z'y', yy', vu\}$. Set $w(yy') = 1$ to ensure satisfying zy and $z'y'$. Set $w(zy) = 1$ and $w(vz') = 3$ to ensure satisfying zv . Next choose $w(z'y')$ to satisfy yy' and $z'x'$. Two choices of $w(vz)$ will satisfy zx . Along with the three choices available for $w(vu)$ these choices can be made to satisfy vz' and $\Gamma_{G'}(v)$. ■

Lemma 4.5. *The following configurations are 3-reducible.*

- A. A 2-vertex or 3-vertex having a 1-neighbor.
- B. A 4^- -vertex whose neighbors all have degree 2.
- C. A 3-vertex having an α -neighbor and another 2-neighbor.
- D. A 4-vertex having a 1-neighbor and a 2^- -neighbor.
- E. A 5^+ -vertex v with $3p_1 + 2p_2 \geq d_G(v)$, where v has p_i i -neighbors.
- F. Two adjacent γ -vertices.

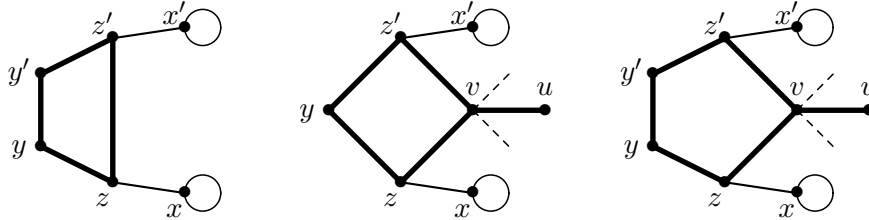

Figure 12. Three cases for Lemma 4.4.

- G.** A 3-vertex with two γ -neighbors.
- H.** A vertex v such that $p_1 + 2q \geq d_G(v)$ and $p_1 + q > 4$, where v has p_1 1-neighbors and q γ -neighbors.
- I.** A 5-vertex having a 1-neighbor and three γ -neighbors.
- J.** A 4-vertex with (1) two α -neighbors, (2) an α -neighbor, another 2-neighbor, and a γ -neighbor, or (3) a 2-neighbor and three γ -neighbors.
- K.** A γ -vertex whose 3^+ -neighbors are all β -vertices.

Proof. Lemma 2.6 shows that **A–E** are 3-reducible. Let G be a minimal 3-bad graph containing one of **F–K**. When z is a γ -vertex with a 3^+ -neighbor v and $w(zv)$ has been chosen, the phrase “apply Lemma 4.3 to z ” means “apply Lemma 4.3 to choose weights on F_z to satisfy F_z and the edges incident to them other than zv ”. In each case, we extend a proper 3-weighting w' of a proper subgraph G' of G to a proper 3-weighting w of G .

The phrase “Figure n is accurate” means that the vertices shown are known to be distinct, except possibly for non- γ -vertices on circles, to which no edges of the core are incident. There are three types of γ -vertices. Let those of degree 4 be γ_4 -vertices, those of degree 3 with an α -neighbor be γ_{3a} -vertices, and those of degree 3 with two 2-neighbors be γ_{3b} -vertices.

Case F: v and v' are adjacent γ -vertices. Let $G' = G - vv' - F_v - F_{v'}$. By symmetry, the first subcase covers when v or v' is a γ_{3b} -vertex. By Lemma 2.5, v and v' do not have a common 2-neighbor.

Subcase F1: v is a γ_{3b} -vertex. Let $N_G(v) = \{v', z, z'\}$. By Lemma 2.5, we may assume $zz', zv', z'v' \notin E(G)$, so Figure 13 is accurate. Set $w(vv') = 3$ to ensure satisfying vz and vz' . Apply Lemma 4.3 to v' . Choose $w(vz)$ to satisfy $\Gamma_{G'}(z)$. Choose $w(vz')$ to satisfy vv' and $\Gamma_{G'}(z')$.

Subcase F2: v and v' are both γ_{3a} -vertices. Let z and z' be the α -neighbors of v and v' , and let y and y' be the 2-neighbors of z and z' . By Lemma 4.4, Lemma 2.5, and **B**, Figure 13 is accurate. Let x and x' be the remaining neighbors of v and v' , respectively. Choose $w(vz)$ to satisfy zy . Now choose $w(v'z')$ to satisfy

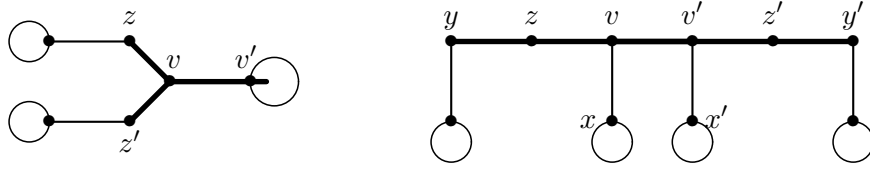

Figure 13. Cases **F1** and **F2** for Lemma 4.5.

vv' and $z'y'$. Next choose $w(vv')$ to satisfy vx and $v'x'$. Finally, choose $w(zy)$ to satisfy vz and $\Gamma_{G'}(y)$, and choose $w(z'y')$ to satisfy $v'z'$ and $\Gamma_{G'}(y')$.

Subcase F3: v and v' are both γ_4 -vertices. Let $N(v) = \{v', z_1, z_2, u\}$ and $N(v') = \{v, z'_1, z'_2, u'\}$, with $d_G(u) = d_G(u') = 1$. For $i \in \{1, 2\}$, let $a_i = w'(vz_i)$ and $b_i = \rho_{w'}(z_i, v)$; similarly define a'_i and b'_i using $\{v', z'_1, z'_2\}$. Since $d_G(u), d_G(u') = 1$, Figure 14 is accurate.

If $a_1 + a_2 > a'_1 + a'_2$, then set $w(uv) = 3$ to ensure satisfying vv' . Next choose $w(vv')$ to satisfy vz_1 and vz_2 , and choose $w(v'u')$ to satisfy $v'z'_1$ and $v'z'_2$.

By symmetry, we may thus assume $a_1 + a_2 = a'_1 + a'_2$. If $b_1 \neq a_2 + 4$, then choose $w(vv') \in \{1, 3\}$ to ensure satisfying vz_1 . Now choose $w(v'u')$ to satisfy $v'z'_1$ and $v'z'_2$, and then choose $w(vu)$ to satisfy vz_2 and vv' . Hence by symmetry we may assume that each entry of (b_1, b_2, b'_1, b'_2) exceeds the corresponding entry of (a_2, a_1, a'_2, a'_1) by exactly 4. Now setting $w(uv) = w(vv') = 3$ and $w(v'u') = 2$ completes the extension.

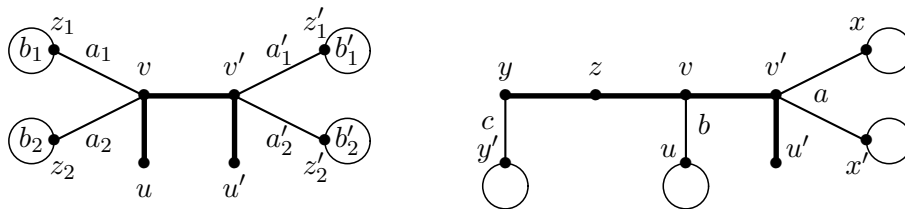

Figure 14. Cases **F3** and **F4** for Lemma 4.5.

Subcase F4: v is a γ_{3a} -vertex and v' is a γ_4 -vertex. Let $N_G(v) = \{v', z, u\}$, with z being the α -vertex. Let y be the 2-neighbor of z , with $N_G(y) = \{z, y'\}$. Let $N_G(v') = \{v, x, x', u'\}$, with $d_G(u') = 1$. By Lemma 2.5 and **D**, Figure 14 is accurate. Let $a = w'(v'x) + w'(v'x')$, $b = w'(vu)$, and $c = w'(yy')$.

If $a \neq b$, then choose $w(u'v') \in \{1, 3\}$ to ensure satisfying vv' . Now choose $w(vv')$ to satisfy $v'x$ and $v'x'$, choose $w(vz)$ to satisfy vu and yz , and choose $w(zy)$ to satisfy vz and the other edge at y .

If $a = b$, then set $w(u'v') = c$. Now choose $w(vv')$ to satisfy $v'x$ and $v'x'$. Next choose $w(vz)$ to satisfy vv' , yz , and uv , which succeeds because vv' and yz both

are satisfied if and only if $w(vz) \neq c$. Finally choose $w(zy)$ to satisfy vz and the other edge at y .

Case G: v is a 3-vertex having two γ -neighbors z and z' . Let $N_G(v) = \{z, z', x\}$. In each case, we will let $G' = G - \{vz, vz'\} - F_z - F_{z'}$ (and w' is a proper 3-weighting of G'). By **F**, $zz' \notin E(G)$. By Lemma 2.5, neither z nor z' shares a 2-neighbor with v or has a 2-neighbor adjacent to a 2-neighbor of v . Hence Figures 15 and 16 are accurate.

Subcase G1: z is a γ_{3a} -vertex. Let $N_G(z) = \{v, y, u\}$, with y the α -neighbor of z . Let y' be the 2-neighbor of y , with $N_G(y') = \{y, y''\}$. Let $a = w'(vx)$, $b = w'(zu)$, and $c = w'(y'y'')$, as shown on the left in Figure 15.

If $b \neq a$, then choose $w(vz') \in \{1, 3\}$ to ensure satisfying vz . With $w(vz')$ known, apply Lemma 4.3 to z' . Next choose $w(vz)$ to satisfy vx and vz' . With vz automatically satisfied and $w(vz)$ chosen, we can now apply Lemma 4.3 to z .

Hence we may assume $b = a$. In this case, set $w(vz') = c$ and apply Lemma 4.3 to z' . Choose $w(vz)$ to satisfy vx and vz' . Now choose $w(zy)$ to satisfy vz , zu , and yy' . This succeeds because yy' and vz both forbid $w(zy) = c$, so at most two choices for $w(zy)$ are forbidden. Finally, choose $w(yy')$ to satisfy zy and $y'y''$.

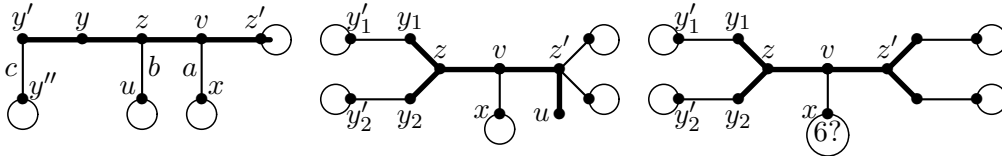

Figure 15. Cases **G1** and **G2** for Lemma 4.5.

Subcase G2: z is a γ_{3b} -vertex. Let $N_G(z) = \{v, y_1, y_2\}$, with $N_G(y_1) = \{z, y'_1\}$ and $N_G(y_2) = \{z, y'_2\}$. By Subcase **G1**, we may assume that z' is not a γ_{3a} -vertex.

If z' is a γ_4 -vertex, with 1-neighbor u as in the middle of Figure 15, then set $w(vz) = 3$ to ensure satisfying zy_1 and zy_2 . Now $w(uz')$ has two choices that satisfy vz' , and $w(vz')$ has two choices that satisfy vx . With at least three choices for the sum $w(uz') + w(vz')$, the two edges in $\Gamma_{G'}(z')$ can also be satisfied. Now choose $w(zy_1)$ to satisfy $\Gamma_{G'}(y_1)$ and $w(zy_2)$ to satisfy zv and $\Gamma_{G'}(y_2)$.

Hence we may assume that z' is also a γ_{3b} -vertex, as on the right in Figure 15. If $\rho_{w'}(x, v) \neq 6$, then set $w(vz) = w(vz') = 3$. This satisfies vx and also ensures satisfying F_z and $F_{z'}$. Choose $w(zy_1)$ to satisfy $y_1y'_1$, and choose $w(zy_2)$ to satisfy $y_2y'_2$ and zv . Choose weights on $F_{z'}$ by the same method.

If $\rho_{w'}(x, v) = 6$ and $w'(y_1y'_1) \neq 3$, then set $w(vz) = 2$ and $w(vz') = 3$ to satisfy vx and ensure satisfying zy_1 . Choose $w(zy_1) \in \{2, 3\}$ to satisfy $y_1y'_1$ and ensure satisfying zy_2 . Now choose $w(zy_2)$ to satisfy $y_2y'_2$ and vz . Since setting

$w(vz') = 3$ ensures satisfying $F_{z'}$, we can choose weights on $F_{z'}$ to finish as in the preceding paragraph.

Hence we may assume that $\rho_{w'}(x, v) = 6$ and (by symmetry) that all edges of G' incident to the 2-neighbors of z and z' have weight 3 under w' . Since we may assume by Subcase **G1** that neither z nor z' is a γ_{3a} -vertex, we can complete the extension by giving all missing edges weight 1 unless $w'(vx) = 1$. In that case, just change $w(vz)$ to 3 and choose $w(zy_i) \in \{2, 3\}$ to satisfy $y_i y'_i$, for $i \in \{1, 2\}$.

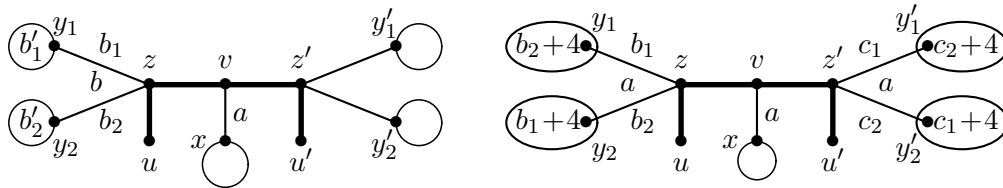

Figure 16. Case **G3** for Lemma 4.5.

Subcase G3: z and z' are both γ_4 -vertices. Let $N_G(z) = \{v, y_1, y_2, u\}$ and $N_G(z') = \{v, y'_1, y'_2, u'\}$, with $d_G(u) = d_G(u') = 1$. Let $a = w'(vx)$. For $i \in \{1, 2\}$, let $b_i = w'(zy_i)$ and $b'_i = \rho_{w'}(y_i, z)$, as on the left in Figure 16.

Let $b = b_1 + b_2$. If $b \neq a$, then choose $w(vz') \in \{1, 3\}$ to ensure satisfying vz . With $w(vz')$ fixed, choose $w(z'u')$ to satisfy $\Gamma_{G'}(z')$. Now choose $w(vz)$ to satisfy vx and vz' , and then choose $w(zu)$ to satisfy $\Gamma_{G'}(z)$ and complete the extension.

If $b'_1 \neq b_2 + 4$, then choose $w(vz) \in \{1, 3\}$ to ensure satisfying zy_1 . Now restrict $w(u'z')$ to two choices that satisfy vz' , and restrict $w(vz')$ to two choices that satisfy vx . Having at least three choices for the sum $w(u'z') + w(vz')$ allows also satisfying the edges of $\Gamma_{G'}(z')$. Finally, choose $w(uz)$ to satisfy zy_2 and zv and complete the extension.

By symmetry, the only remaining case is $b = a$, $b'_1 = b_2 + 4$, and $b'_2 = b_1 + 4$, and similarly for $\Gamma_{G'}(z')$, as on the right in Figure 16. Now $w(vz) + w(zu) < 4$ satisfies zy_1 and zy_2 , and $w(uz) \neq w(vz')$ satisfies vz . Similarly, $w(vz') + w(z'u') > 4$ satisfies $z'y'_1$ and $z'y'_2$, and $w(u'z') \neq w(vz)$ satisfies vz' . Set $w(vz) = w(zu) = 1$ and $w(z'u') = 3$, and choose $w(vz') \in \{2, 3\}$ to satisfy vx .

Case H: A vertex v such that $p_1 + 2q \geq d_G(v)$ and $p_1 + q > 4$. Let Z be the set of γ -neighbors of v . Let R be the set of edges from v to 1-neighbors and to Z , shown bold in Figure 17. By **F**, the set Z is independent. Form G' from G by deleting R and F_z for each $z \in Z$. Here v and a γ -neighbor of v play the roles of x and v in Figure 11, respectively.

Let R' be a set of $d_G(v) - p_1 - q$ edges in $[v, Z]$. Give all of $R - R'$ weight 3. Choose weights on R' from $\{2, 3\}$ to satisfy the $d_G(v) - p_1 - q$ edges in $\Gamma_{G'}(v)$.

Consider vz with $z \in Z$. Including the weights on $\Gamma_{G'}(v)$, the sum of the weights on $\Gamma_G(v) - \{vz\}$ is now at least $3(q-1) + 3p_1$, which by hypothesis exceeds

9. At most three edges are incident to vz at z , so vz is automatically satisfied, as are the edges from v to 1-neighbors. Now the weights on R are fixed; apply Lemma 4.3 to the vertices of Z .

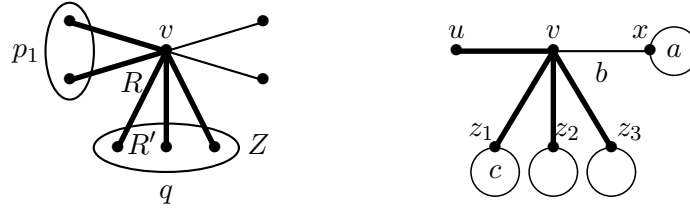

Figure 17. Cases **H** and **I** for Lemma 4.5.

Case I: A 5-vertex v having a 1-neighbor and three γ -neighbors. The argument of Case **H** does not suffice here, since $p_1 + q = 4$. Let u be the 1-neighbor of v , and let z_1, z_2, z_3 be its γ -neighbors. As in **H**, let $R = \{vu, vz_1, vz_2, vz_3\}$ (bold on the right in Figure 17), and let $G' = G - R - \bigcup_i F_{z_i}$. Let $a = \rho_{w'}(x, v)$, and let $b = w'(vx)$. By Lemma 4.4, we may assume that no two of the γ -neighbors are 3-vertices with a common 2-neighbor, and by **F** they form an independent set. Hence Figure 17 is accurate.

If $a \neq 12$, then put weight 3 on all edges of R to satisfy vx and ensure satisfying $\{vz_1, vz_2, vz_3\}$. Finally, apply Lemma 4.3 to each z_i .

If $a = 12$, then set $w(vz_1) = 2$ so that vx is automatically satisfied. Having specified $w(vz_1)$, apply Lemma 4.3 to z_1 . Now let $c = \rho_w(z_1, v)$. If $c \leq 7$, or if $c = 8$ and $b \geq 2$, then set $w(vz_2) = w(vz_3) = 3$ to ensure satisfying vz_1 . If $c = 9$, or if $c = 8$ and $b = 1$, then set $w(vz_2) = w(vz_3) = 1$ to ensure satisfying vz_1 . Next apply Lemma 4.3 to z_2 and z_3 . Finally, choose $w(vu)$ to satisfy vz_2 and vz_3 .

Case J: A 4-vertex with specified neighbors. As usual, by the prior lemmas and reducible configurations, Figure 18 is accurate.

Subcase J1: A 4-vertex v with α -neighbors z and z' . Let $N_G(z) = \{v, y\}$ and $N_G(z') = \{v, y'\}$, as in Figure 18. By Lemma 2.5, we may assume $\{y, y'\} \cap \{z, z'\} = \emptyset$. By **B**, we have $y \neq y'$ and $yy' \notin E(G)$. Let $G' = G - \{vz, vz', zy, z'y'\}$. At least two choices for $w(vz)$ satisfy zy , and similarly two choices for $w(vz')$ satisfy $z'y'$. This yields at least three choices for $w(vz) + w(vz')$, which is enough to satisfy $\Gamma_{G'}(v)$. Finally, choose $w(zy)$ to satisfy its two incident edges and $w(z'y')$ to satisfy its two incident edges.

Subcase J2: A 4-vertex v with an α -neighbor z , another 2-neighbor u (that is not an α -vertex), and a γ -neighbor x . Name the vertices (uniquely) so that y', y, z, v, u, u' form a path in order, and let x' be the remaining neighbor of v , as in Figure 18. Let $G' = G - \{yz, zv, vu, vx\} - F_x$. Set $w(vx) = 2$ to ensure satisfying vu . Apply Lemma 4.3 to x . At least two choices for $w(vu)$ satisfy

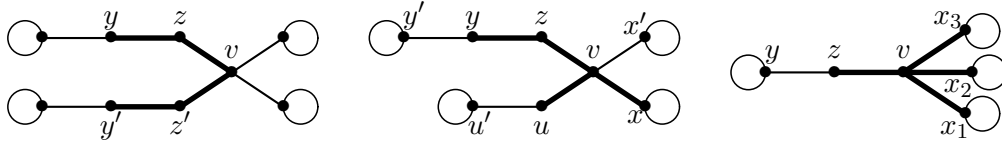

Figure 18. Cases **J1**, **J2**, **J3** for Lemma 4.5.

uu' , and at least two choices for $w(vz)$ satisfy yz . With at least three choices for $w(vu) + w(vz)$, at least one choice satisfies vx and vx' . Finally, choose $w(yz)$ to satisfy vz and yy' .

Subcase J3: A 4-vertex v with a 2-neighbor z and three γ -neighbors x_1, x_2, x_3 . Let $N(z) = \{v, y\}$, as in Figure 18. Let $G' = G - \Gamma_G(v) - \bigcup_i F_{x_i}$.

If $d(x_1) = 3$, or if $d(x_1) = 4$ and $\phi_{w'}(x_1) \leq 4$, then the value of $\rho_w(x_1, v)$ will be at most 7, since when $d(x_1) = 4$ there is only one edge in F_{x_1} (the edge incident to the 1-neighbor of x_1). Hence setting $w(vx_2) = w(vx_3) = 3$ and restricting $w(zv)$ to $\{2, 3\}$ ensures satisfying vx_1 and vz . Apply Lemma 4.3 to x_2 and x_3 . Now choose $w(zv)$ (in $\{2, 3\}$) to satisfy yz , and then choose $w(vx_1)$ to satisfy vx_2 and vx_3 . Finally, apply Lemma 4.3 to x_1 .

By symmetry, we may now assume $d(x_i) = 4$ and $\phi_{w'}(x_i) \geq 5$ for all i . Choose $w(vz) \in \{1, 2\}$ to satisfy zy . Set $w(vx_1) = 2$ and $w(vx_2) = w(vx_3) = 1$ to ensure satisfying all edges incident to v . Finally, apply Lemma 4.3 to each x_i .

Case K: v is a γ -vertex whose 3^+ -neighbors are all β -vertices. See Figure 19. Let S be the set of neighbors of v whose degrees are not specified by the definition of v being a γ -vertex. By **{B,C,D}**, all vertices of S are 3^+ -vertices. By **F**, they cannot be γ -vertices, so by the hypothesis of this case, each vertex of S has degree 3, with one 2-neighbor and one 3^+ -neighbor other than v (by **A**). By Lemmas 2.5 and 4.4 and Cases **B** and **F**, Figure 19 is accurate in each subcase.

Subcase K1: v is a γ_{3b} -vertex. Let $N_G(v) = \{z, z', u\}$, where $d_G(u) = 3$. Let y be the 2-neighbor of u . Let $G' = G - \Gamma_G(v) - uy$. Set $w(vu) = 3$ to ensure satisfying all of $\{vz, vz', uy\}$. Choose $w(uy)$ to satisfy its two incident edges other than vu . Choose $w(vz)$ to satisfy the other edge at z , and choose $w(vz')$ to satisfy vu and the other edge at z' .

Subcase K2: v is a γ_4 -vertex. Let $N_G(v) = \{z_1, z_2, z_3, u\}$, with $d_G(u) = 1$. Let y_i be the 2-neighbor of z_i . Let $G' = G - \Gamma_G(v) - \{z_1y_1, z_2y_2, z_3y_3\}$. For each i , set $w(vz_i) = 3$ to ensure satisfying z_iy_i , and choose $w(z_iy_i)$ to satisfy its two incident edges other than z_iy_i . Also vz_1, vz_2, vz_3 are satisfied.

Subcase K3: v is a γ_{3a} -vertex. Let u be the α -neighbor of v (with $N_G(u) = \{v, u'\}$). By **C**, v does not have another 2-neighbor. Let $N_G(z) = \{v, x, y\}$ and

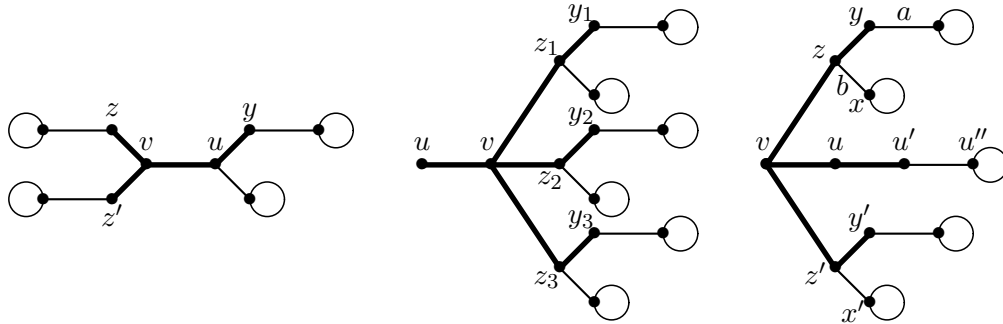

Figure 19. Cases **K1**, **K2**, **K3** for Lemma 4.5.

$N_G(z') = \{v, x', y'\}$, with $d_G(y) = d_G(y') = 2$. By **J**, each β -neighbor of v is not a γ -vertex, which means that the other neighbors of y and y' are 3^+ -vertices.

Let $G' = G - \Gamma_G(v) - \{uu', zy, z'y'\}$. Let a and b be the weights under w' of the edges at y and z in G' , respectively. Set $w(vz') = 3$ to ensure satisfying $z'y'$, and choose $w(z'y')$ to satisfy the edges incident to $z'y'$ other than vz' .

If $a \leq b$, then zy is automatically satisfied. Choose $w(zy)$ to satisfy $\Gamma_{G'}(y)$. Now choose $w(vu)$ to satisfy vz and uu' , and then choose $w(vz)$ to satisfy vz' and zx . Finally, choose uu' to satisfy vu and $u'u''$.

If $a > b$, then setting $w(zy) = 1$ ensures satisfying the other edge at y (its other endpoint has degree at least 3). With $b \leq 2$ and $w(vz') = 3$, the edge vz is automatically satisfied. Now choose $w(vz)$ to satisfy the other edges at z , choose $w(vu)$ to satisfy vz' and uu' , and choose $w(uu')$ to satisfy its incident edges. ■

Theorem 4.6. *Every graph G with $\text{Mad}(G) < \frac{8}{3}$ has a proper 3-weighting.*

Proof. It suffices to show that every configuration in the unavoidable set in Lemma 4.2 is shown to be 3-reducible in Lemma 4.5. The configurations are the same in the two lemmas except for **H** and **J**.

For **H**, if $d_G(v) \in \{6, 7\}$ and v has a 1-neighbor and four γ -neighbors, then $p_1 + 2q \geq d_G(v)$ and $p_1 + q > 4$. For **J**, a 4-vertex v with $p + q + r \geq 5$ must have an α -neighbor. If v has another α -neighbor, then **J1** applies. If v has a γ -neighbor and another 2-neighbor, then **J2** applies. Otherwise, all other neighbors are γ -neighbors (reducible by **J3**) or all are 2-neighbors (reducible by **B**). ■

Some of the 3-reducible configurations in Lemma 4.5 are more general than the configurations forced in Lemma 4.2. Also, there are other 3-reducible configuration we have not used, such as (1) a 4-vertex having two 2-neighbors and one γ -neighbor and (2) a more general version of configuration **H**. This suggests that with more work this approach could be pushed to prove the conclusion under a weaker restriction on $\text{Mad}(G)$.

REFERENCES

- [1] L. Addario-Berry, K. Dalal, C. McDiarmid, B.A. Reed and A. Thomason, *Vertex-colouring edge-weightings*, *Combinatorica* **27** (2007) 1–12.
doi:10.1007/s00493-007-0041-6
- [2] L. Addario-Berry, K. Dalal and B.A. Reed, *Degree constrained subgraphs*, *Discrete Appl. Math.* **156** (2008) 1168–1174.
doi:10.1016/j.dam.2007.05.059
- [3] N. Alon, *Combinatorial Nullstellensatz*, *Combin. Probab. Comput.* **8** (1999) 7–29.
doi:10.1017/S0963548398003411
- [4] T. Bartnicki, J. Grytczuk and S. Niwczyk, *Weight choosability of graphs*, *J. Graph Theory* **60** (2009) 242–256.
doi:10.1002/jgt.20354
- [5] M. Kalkowski, *A note on the 1, 2-conjecture*, submitted (also in Ph.D. Thesis, 2009).
- [6] M. Kalkowski, M. Karoński and F. Pfender, *Vertex-coloring edge-weightings: towards the 1-2-3-conjecture*, *J. Combin. Theory (B)* **100** (2010) 347–349.
doi:10.1016/j.jctb.2009.06.002
- [7] M. Karoński, T. Łuczak and A. Thomason, *Edge weights and vertex colours*, *J. Combin. Theory (B)* **91** (2004) 151–157.
doi:10.1016/j.jctb.2003.12.001
- [8] J. Przybyło and M. Woźniak, *On a 1, 2 conjecture*, *Discrete Math. Theoret. Comput. Sci.* **12** (2010) 101–108.
- [9] B. Seamone, *The 1-2-3 conjecture and related problems: a survey*, submitted (<http://arxiv.org/abs/1211.5122>).
- [10] T. Wang and Q. Yu, *On vertex-coloring 13-edge-weighting*, *Front. Math. China* **3** (2008) 581–587.
doi:10.1007/s11464-008-0041-x
- [11] T.-L. Wong, X. Zhu and D. Yang, *List total weighting of graphs*, in: G.O.H. Katona, A. Schrijver, T. Szőnyi and G. Sági, Eds., *Fete of Combinatorics and Computer Science*, *Bolyai Soc. Math. Stud.*, vol. 20 (Springer, Berlin, Heidelberg, 2010) 337–353.
doi:10.1007/978-3-642-13580-4_13
- [12] T.-L. Wong and X. Zhu, *Total weight choosability of graphs*, *J. Graph Theory* **66** (2011) 198–212.
doi:10.1002/jgt.20500
- [13] T.-L. Wong and X. Zhu, *Every graph is (2, 3)-choosable*, submitted.

Received 29 March 2013
 Revised 13 November 2013
 Accepted 13 November 2013